

**NOTICE DE MONTAGE
ASSEMBLING INSTRUCTIONS
ISTRUZIONI DI MONTAGGIO
MONTAGEANLEITUNG
ISTRUCOES DE MONTAGEM
MANUAL DE MONTAJE
UPUTE O MONTAŽ**

SEVILLA PET SEVS23

PRODUCT CODE: 624313

Version: 27- 07.2022

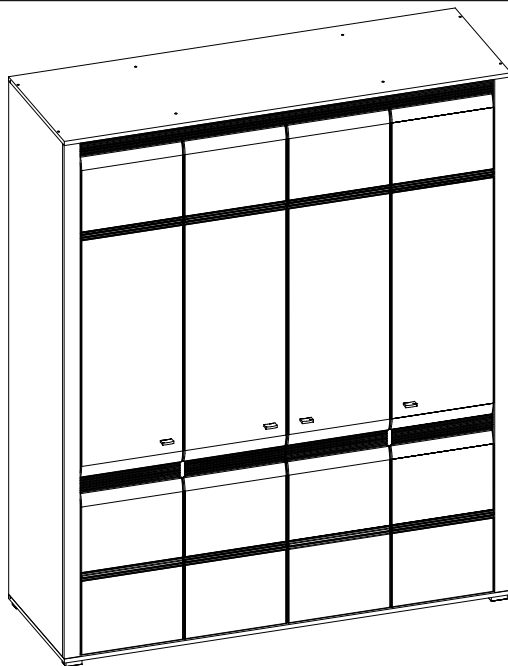
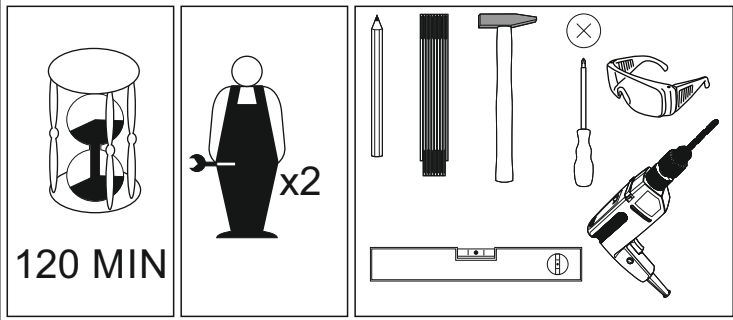

*AVANT DE COMMENCER, SE
REPORTER AUX CONSEILS
DE MONTAGE EN ANNEXE*

**BEFORE STARTING, REFER
TO THE ASSEMBLING ADVICE
IN ANNEX**

*VOR DER MONTAGE,
BEILIEGENDE ANWEISUNGEN
BEFOLGEN.*

**PRIMA DI COMINCIARE LEGGETE
LE ISTRUZIONI DI MONTAGGIO**

*ANTES DE COMERCAR, ADIAR
SE AOS CONSELHOS DE
MONTAGEM EM ANEXO*

**ANTES DE EMPEZAR
CONSULTE LOS CONSEJOS
PARA EL MONTAJE**

**PRIJE POČETKA MONTAŽE
MOLIMO PAŽLJIVO
PROČITAJTE UPUTE ZA
MONTAŽU**

**BASLAMADAN ÖNCE,
EKTEKI MONTAJ TALIMATLARINI
İNCELEYİNİZ**

**PRE POČETKA MONTAŽE MOLIMO
PAŽLJIVO PROČITAJTE UPUTSTVO
ZA MONTAŽU**

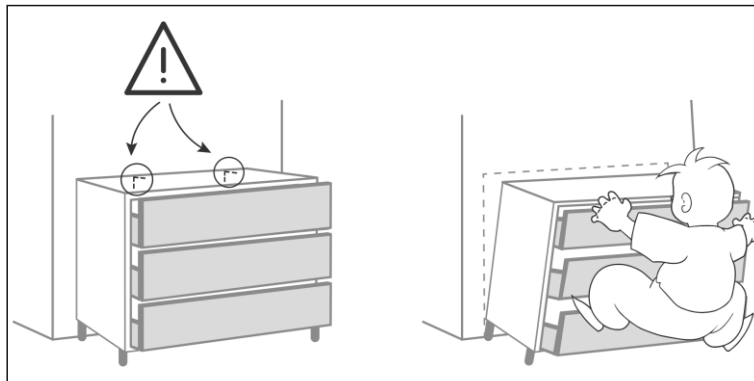

FRANCE	
CODE INFORMATIQUE	

SWITZERLAND	
CODE INFORMATIQUE	
INFORMATIK CODE	
CODICE INFORMATICO	

ESPANA	
CODIGO INFORMATICO	

Türkiye	
BİLGISAYAR KODU	

PORTUGAL	
CODEGO INFORMATICO	

ITALIA	
CODICE INFORMATICO	

HRVATSKA	
KOD	624313

SRBIJA	
ŠIFRA ARTIKLA	624313

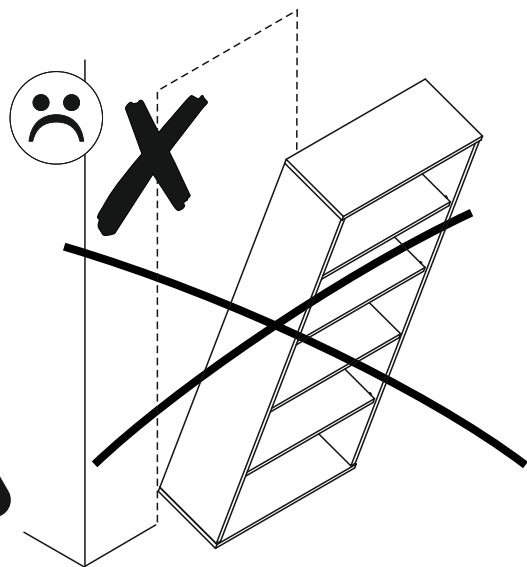
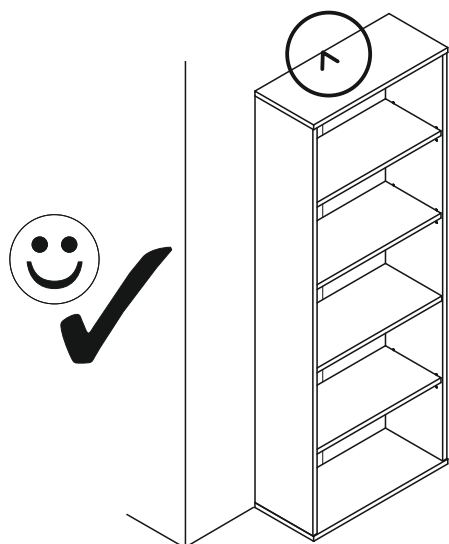

PL.
UWAGA! Mebel należy trwale zamocować do ściany, aby uniknąć ryzyka związanego z przewróceniem się mebla.
 W paczce nie ma śrub mocujących, ponieważ rodzaj mocowania należy odpowiednio dobrać do rodzaju ściany. Dobierz właściwe do Twojego rodzaju ściany.

SK.
POZOR! Nábytok musí byť trvalo pripevnený k stene tak, aby sa zamedzilo riziku prevrátenia. Balík neobsahuje upevňovacie skrutky, pretože typ upevnenia je treba vybrať podľa typu steny. Vyberte typ vhodný pre Vašu stenu.

FR.
ATTENTION! Ce meuble doit être fixé en permanence au mur pour éviter les risques de chute. Les vis de fixation ne sont pas livrées car le type de fixation doit être choisi en fonction du type de mur. Sélectionnez les fixations adaptées au mur.

HU.
FIGYELEM! Rögzítse a bútorokat a falhoz, hogy elkerülje a bútor felborulásának kockázatát. A készletben nem találhatóak rögzítőcsavarok, mivel a rögzítés típusa a fal típusától függ. Válassza ki a fal típusának megfelelő kötőelemeket.

HR.
NAPOMENA! Namještaj mora biti trajno pričvršćen za zid, kako bi se izbjegao rizik od njegovog prevrtanja. U paketu nema vijaka za pričvršćivanje, jer se vrsta montaže mora prilagoditi vrsti zida. Odaberite pravu vrstu prema Vašoj vrsti zida.

EN.
WARNING! To prevent this furniture from tripping over, fix it to the wall permanently. Fixing devices are not included since different wall materials require different types of fixing devices. Please make sure you chose the correct ones for your type of wall.

D.
ACHTUNG! Um alle mit dem Umkippen des Möbels verbundenen Risiken auszuschließen, muss das Möbel fest an der Wand verankert werden. Beschläge für die Wandbefestigung sind nicht beige packt, da diese von der jeweiligen Wandbeschaffenheit abhängig sind. Bitte solche Befestigungsschläge wählen, die für die heimischen Wände geeignet sind.

CZ.
POZOR! Nábytek je nutné pevně připevnit ke zdi, abychom se vyhnuli riziku spojenému s jeho převrnutím. Součástí balení nejsou připevňovací šrouby, protože způsoby připevnění je nutné zvolit podle druhu stěny. Vyberte správný pro Váš typ stěny.

E.
¡ATENCIÓN! El mueble debe ser fijado permanentemente a la pared para evitar el riesgo relacionado con el vuelco del mueble. En el paquete no hay tornillos de fijación, ya que se debe elegir el tipo de fijación adecuada para el tipo de pared. Elija el apropiado para su tipo de pared.

CN.
注意! 本家具需要固定在墙上以免倒塌。箱子里没有安装螺钉。因为安装方式需要根据墙的类型调整。请按照您的墙类型选择合适的安装方式。

RU.
ПРИМЕЧАНИЕ! Эту мебель необходимо всегда прикреплять к стене, чтобы избежать рисков, связанных с переворотом мебели. В пакете нет крепежных винтов, потому что тип крепления должен быть выбран в соответствии с типом стены. Выберите, пожалуйста, правильные винты к вашей стене.

SLO.
POZOR! Pohištvo trajno pritrdite na steno, da preprečite tveganje, da se prevrne. V paketu ni pritrdilnih vijakov, saj je treba način pritrditve ustrezno izbrati glede na vrsto stene. Izberite način, ki je ustrezen za vašo steno.

I.
ATTENZIONE! Il mobile deve essere permanentemente fissato alla parete per evitare i rischi derivanti da un ribaltamento del mobile. La confezione non include le viti di fissaggio, in quanto il tipo di fissaggio deve essere scelto in base al tipo di parete. Utilizzare viti appropriate in base al materiale della parete.

NOTICE DE MONTAGE
ASSEMBLING INSTRUCTIONS
ISTRUZIONI DI MONTAGGIO
MONTAGEANLEITUNG
ISTRUCOES DE MONTAGEM
MANUAL DE MONTAJE
UPUTE O MONTAŽ

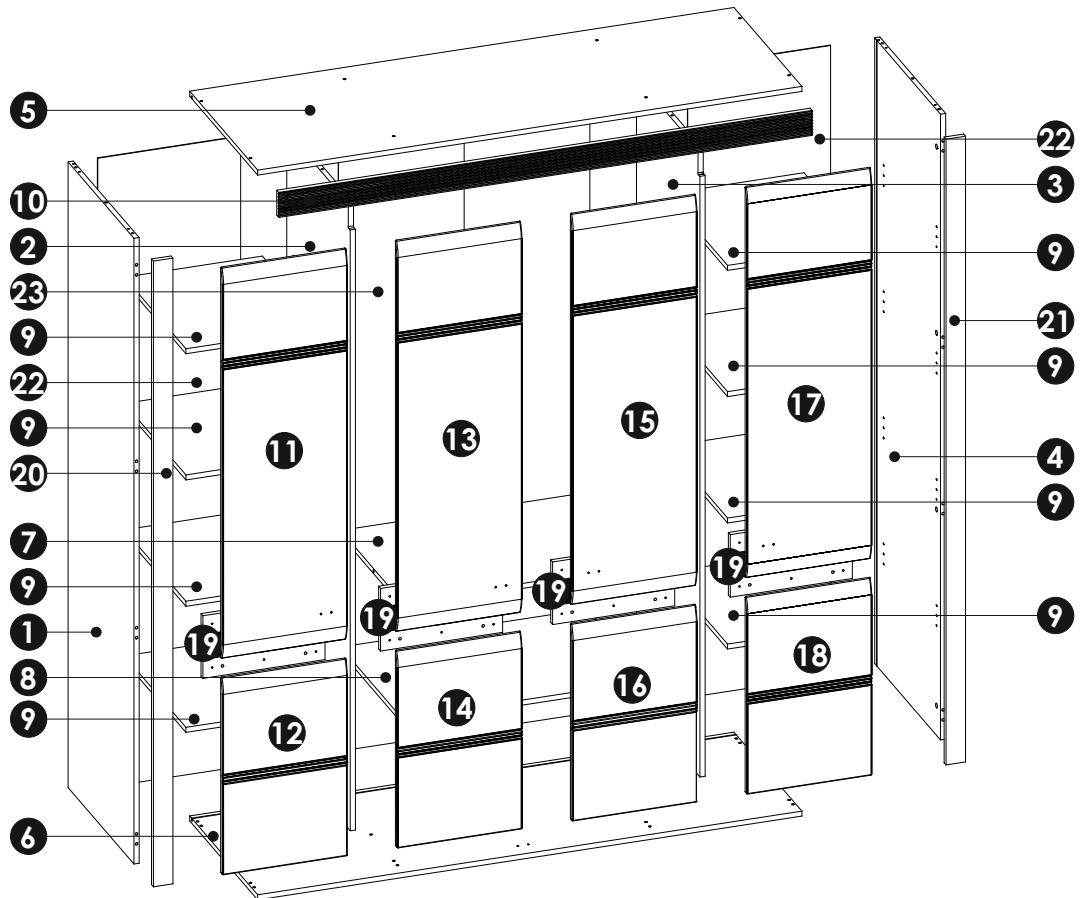

a0 8x20 x...(x16)	a1 8x35 x...(x38)	b0 + b2a x...(x8)	b0 + br3 x...(x8)	c1 Euro 4x13 x...(x32)	d2 x...(x36)	dr L-752 x...(x1)	e0 x...(x12)		
e1 x...(x12)	f1 7x50 x...(x16)	g0 x...(x16)	g1 7x50 x...(x16)	h1 x...(x4)	i2 4x16 x...(x2)	i4 4x27 x...(x4)	i10 3,5x22 x...(x8)	j2 4x25 x...(x24)	i5 3,5x27 x...(x2)
k3 M4x22 x...(x8)	m x...(x1)	n0 3x13 x...(x1)	n1 3x16 x...(x35)	n2 3,5x16 x...(x10)	o1 x...(x2)	o2 x...(x4)	p16 x...(x24)		
q9 x...(x2)	r1 x...(x26)	r4 x...(x18)	r5 x...(x1)	r8 x...(x8)	w x...(x4)	z1 x...(x2)			

- 1**
- a1** 8x35 x10
- d2** x8
- e1** x4

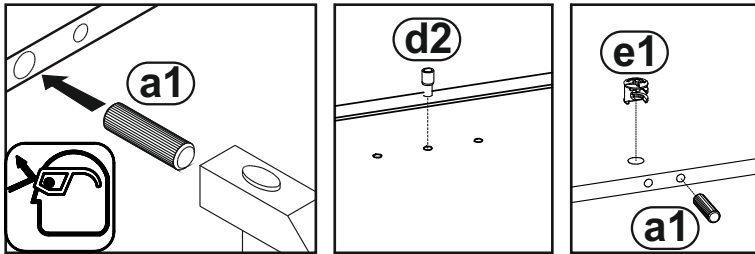
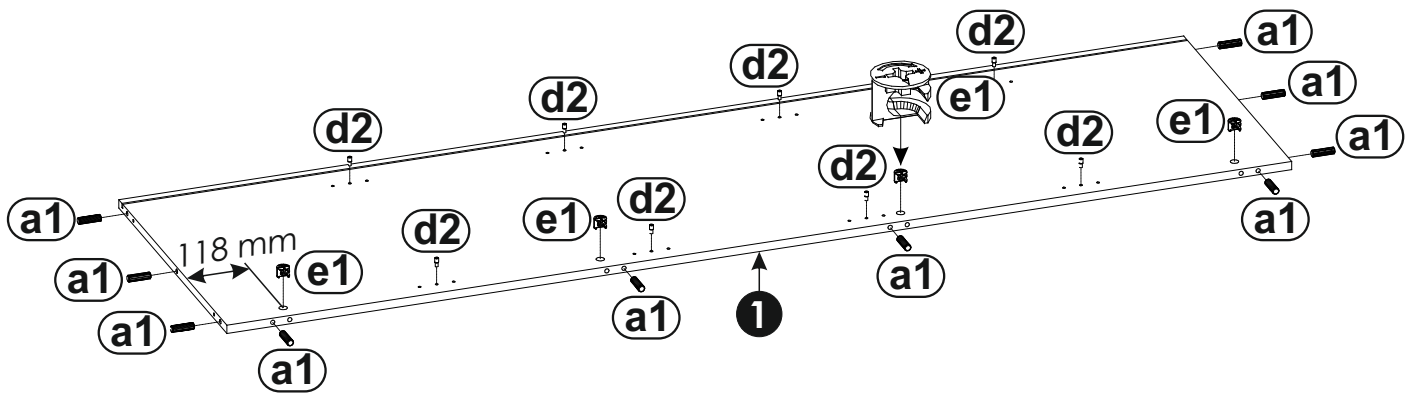

- 2**
- a1** 8x35 x6
- b0** x4
- d2** x10
- f1** x2
- n2** 3,5x16 x1
- z1** x1

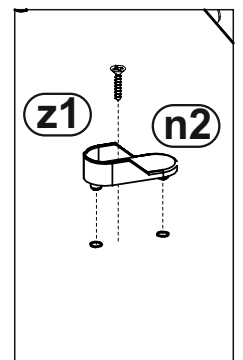
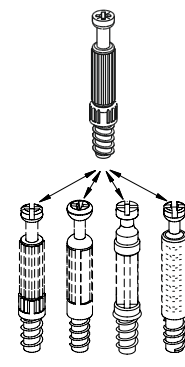
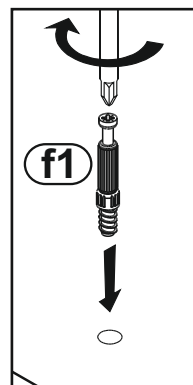
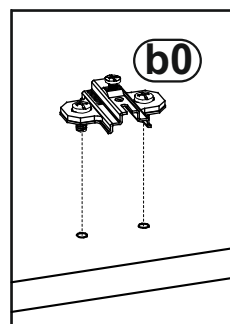
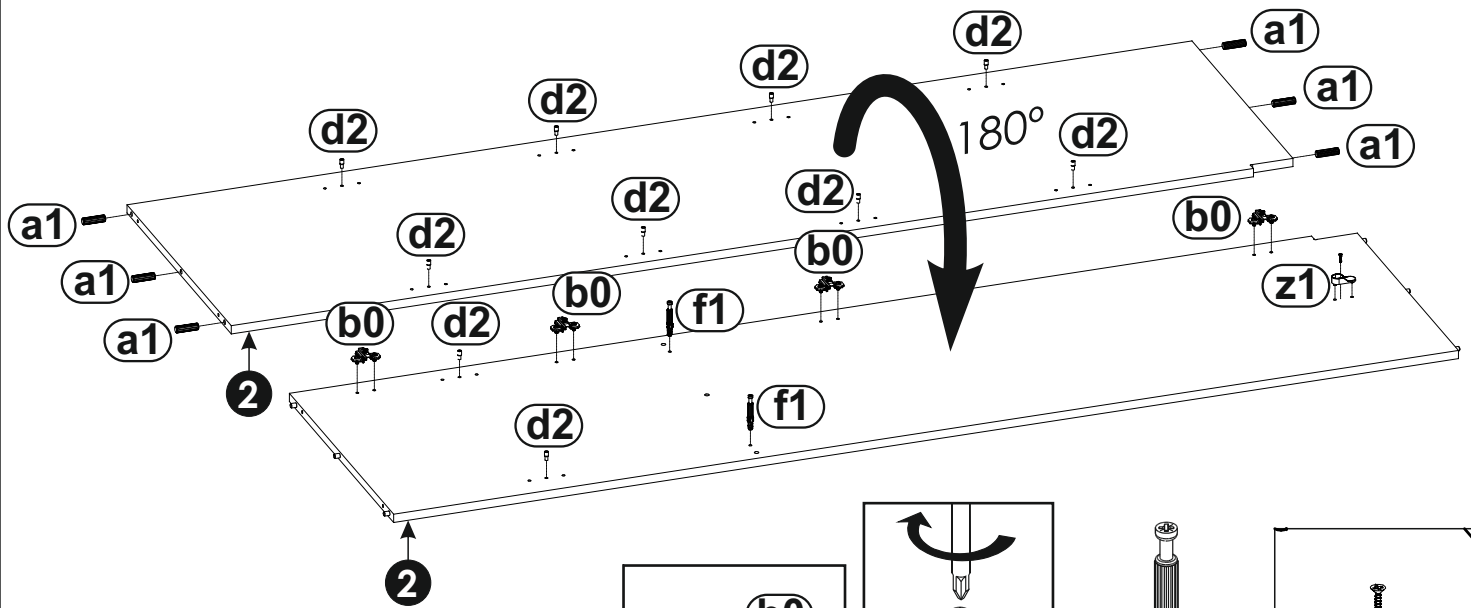

3	a1 8x35 x6	b0 x4	d2 x10	f1 x2	n2 3,5x16 x1	z1 x1
----------	-------------------------	-----------------	------------------	-----------------	---------------------------	-----------------

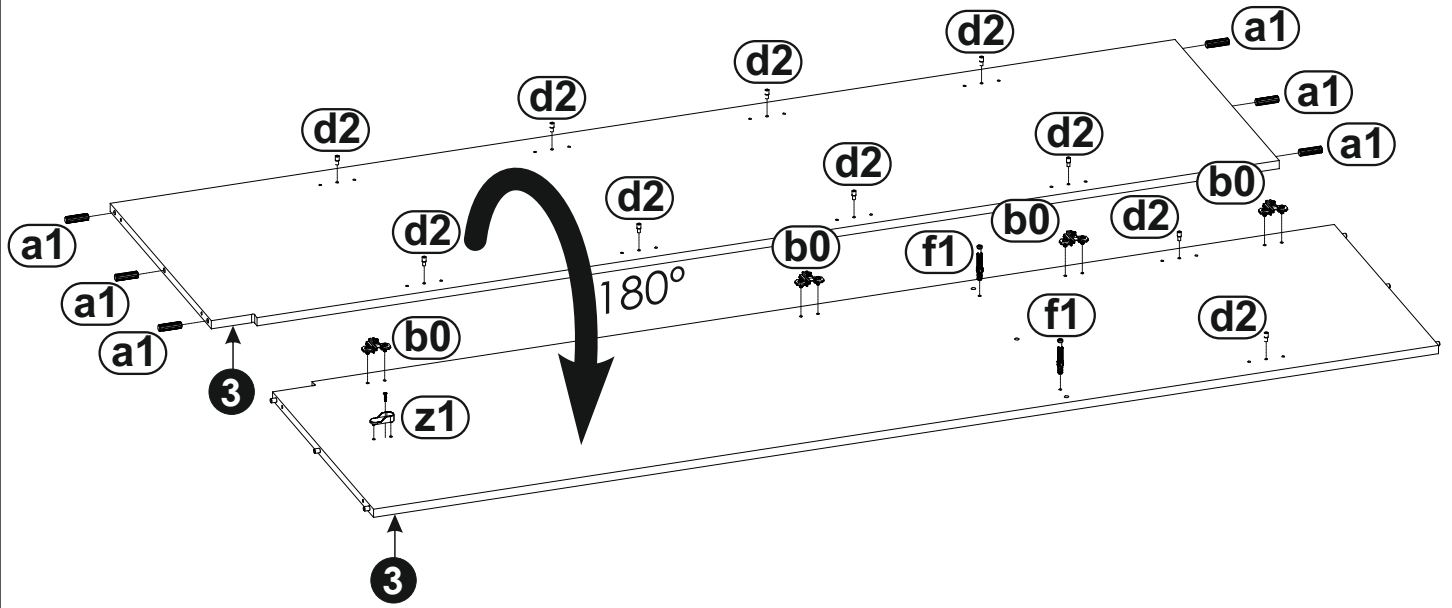

4	a1 8x35 x10	d2 x8	e1 x4
----------	--------------------------	-----------------	-----------------

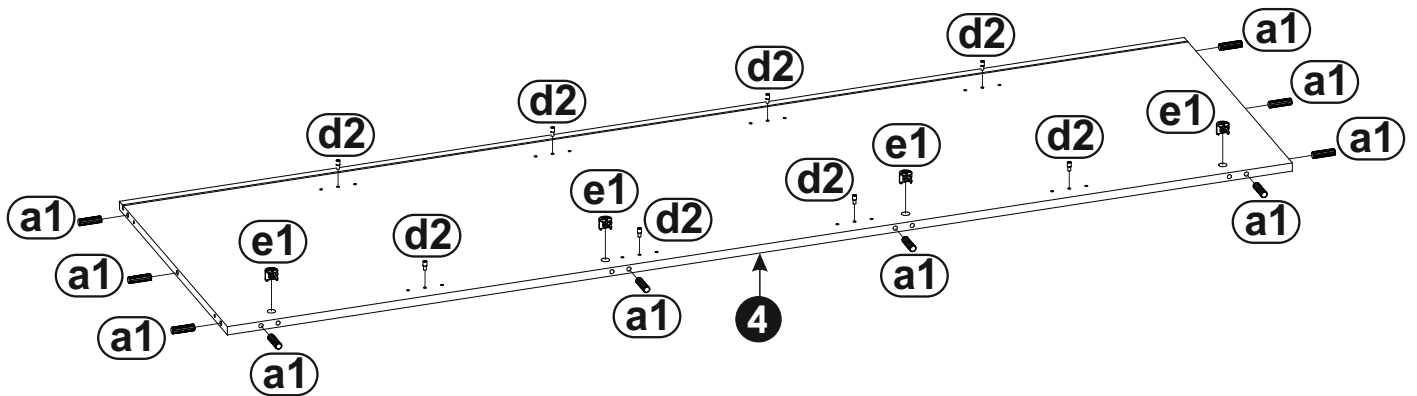

5	i10 3,5x22 x8	i5 3,5x27 x...(x2)	n0 3x13 x1	o1 x2	o2 x4	r5 x1
----------	----------------------------	---------------------------------	-------------------------	-----------------	-----------------	-----------------

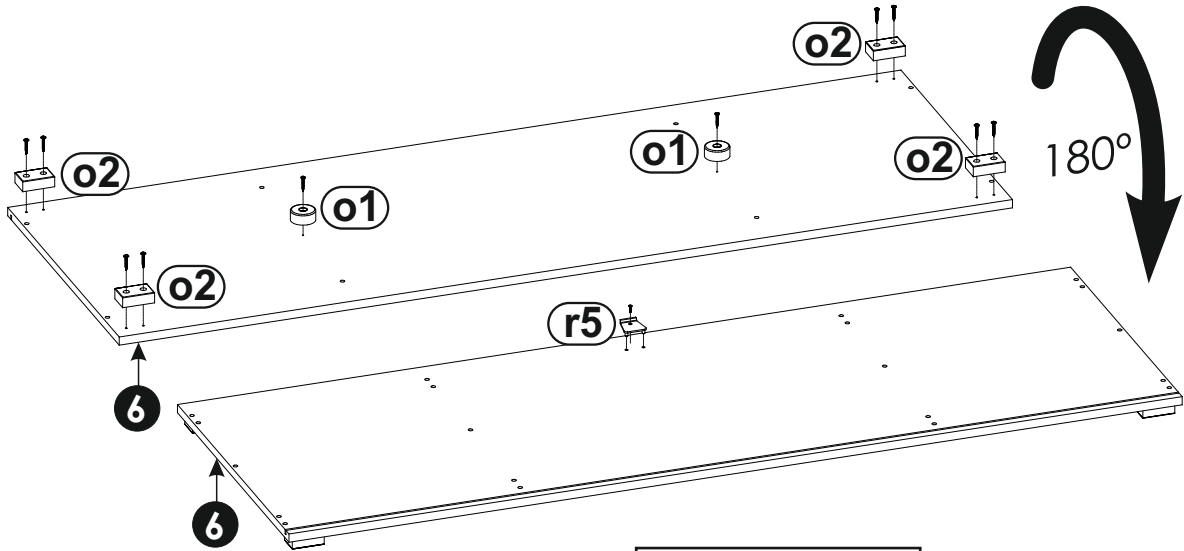

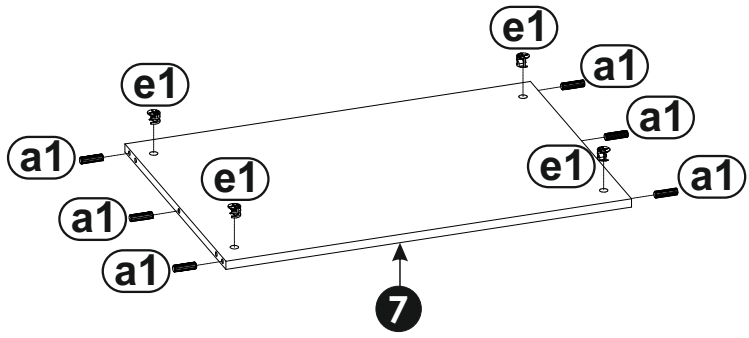

n0 r5	i5 o1	i10 i10 o2
-----------------	-----------------	-----------------------------

6	a1 8x35 x6	e1 x4
----------	-------------------------	-----------------

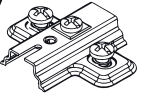

7

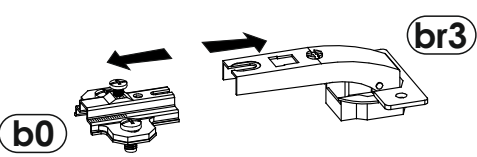

b0		f1	
	x4		x4

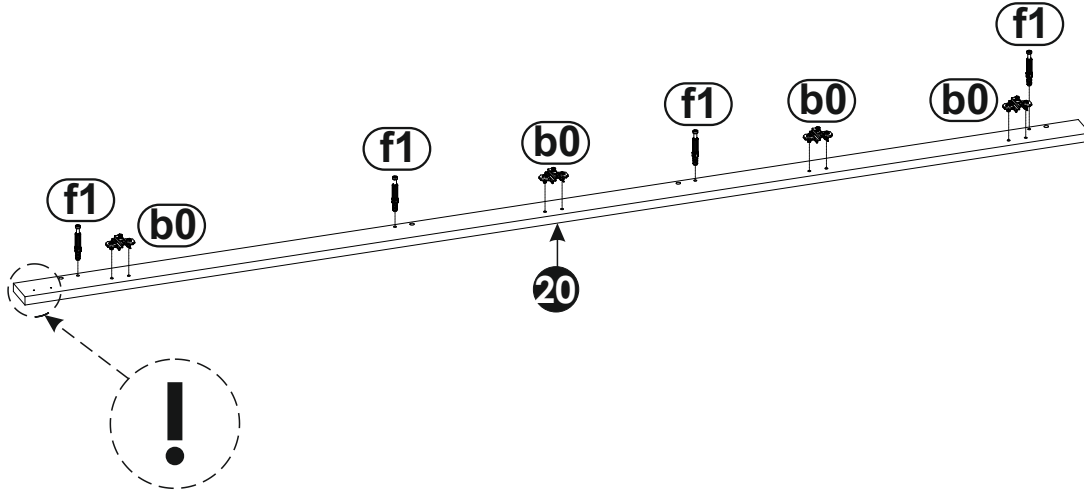

b0 **br3**



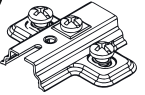

8

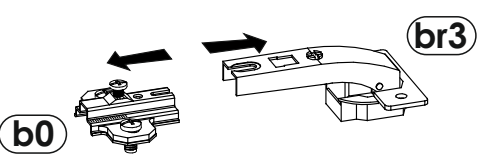
b0		f1	
	x4		x4



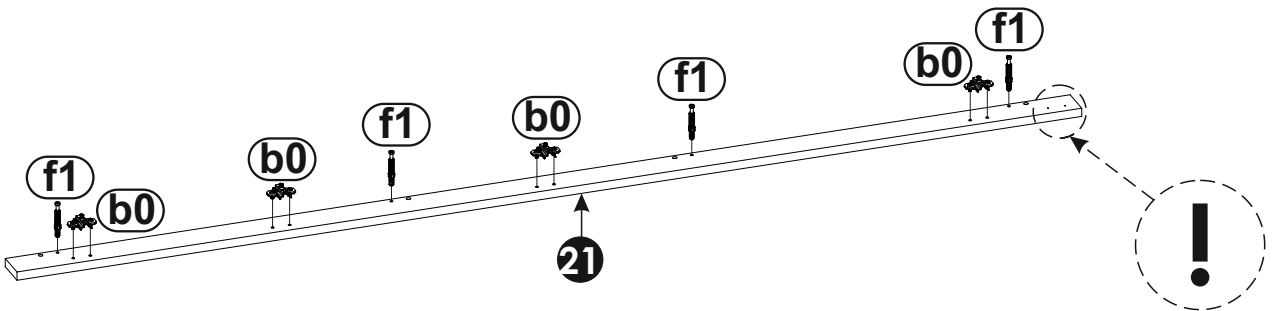

b0 **br3**

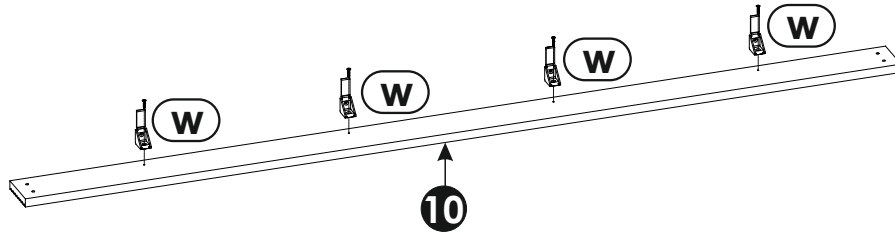
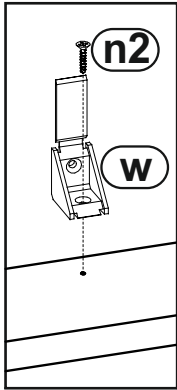

9	n2  3,5x16 x4	w  x4
----------	--	---



10	e0  x4	m  x1
-----------	--	---

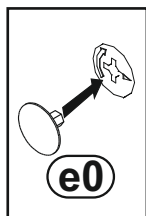
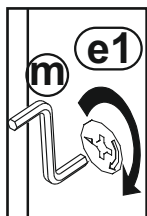
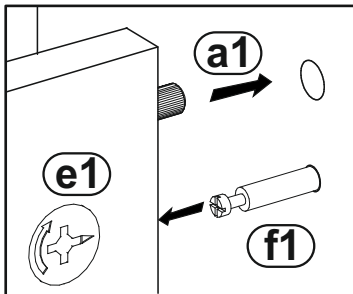
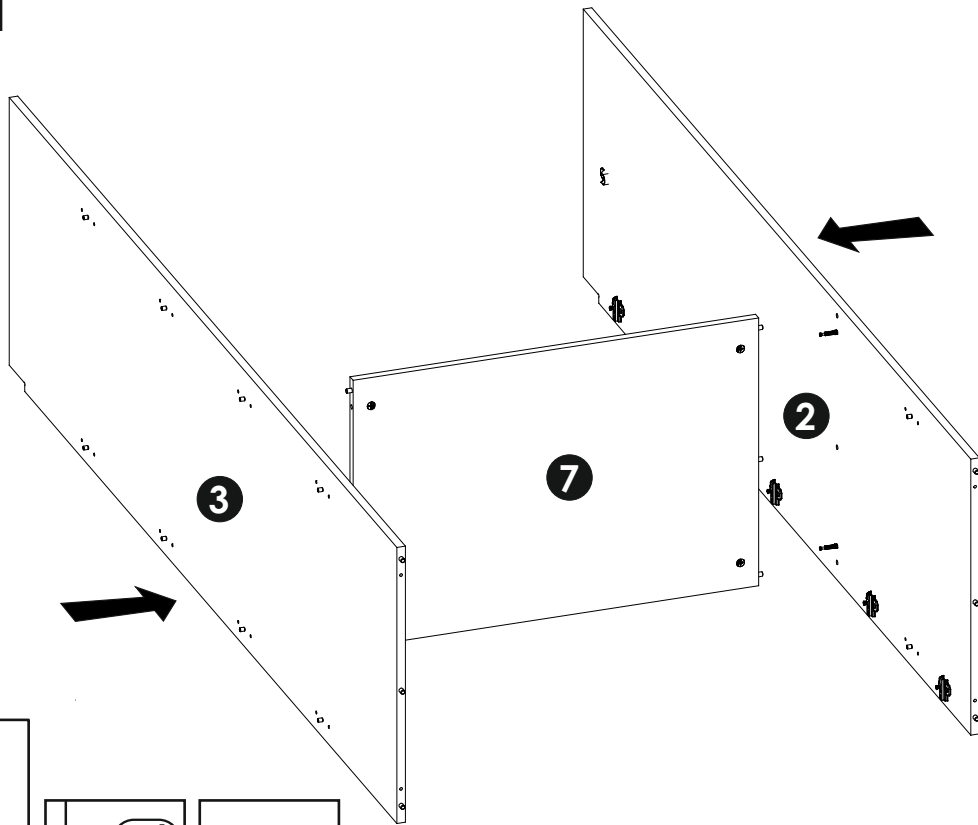

11

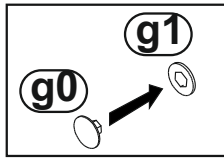
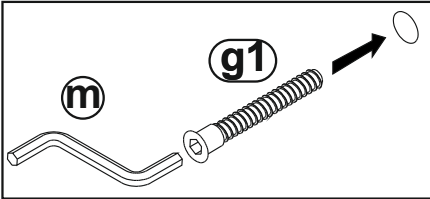
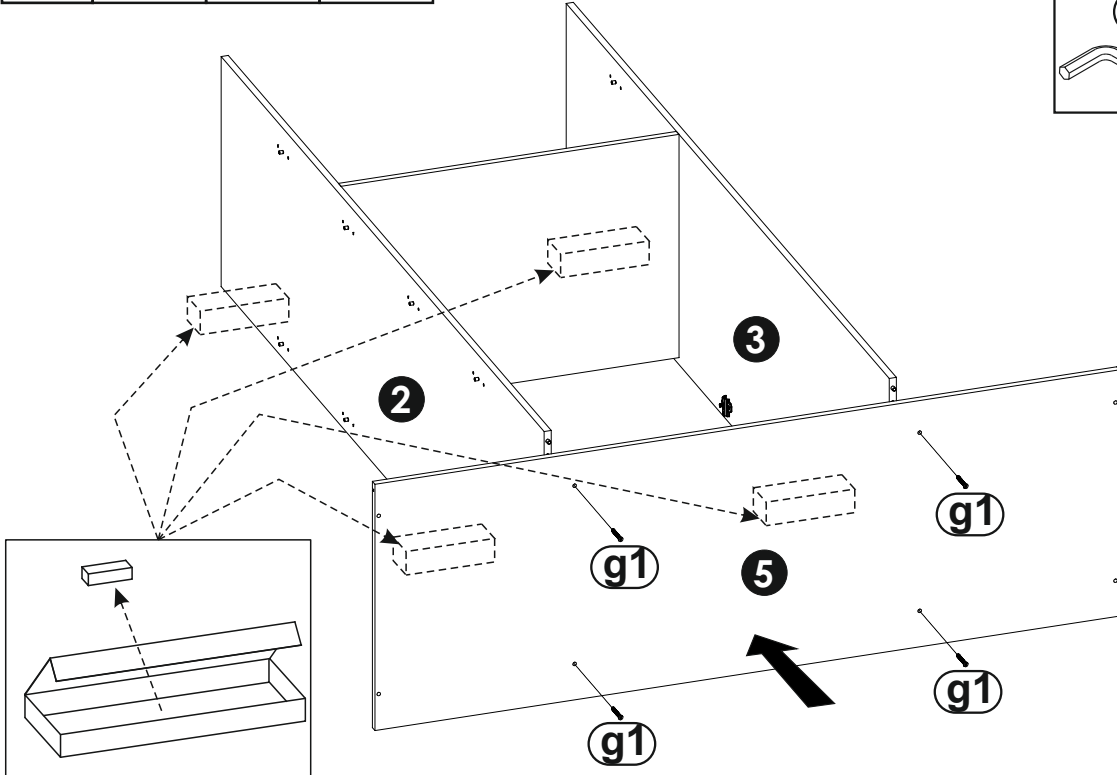
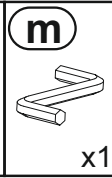

12

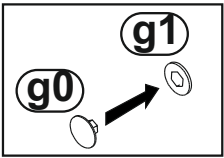
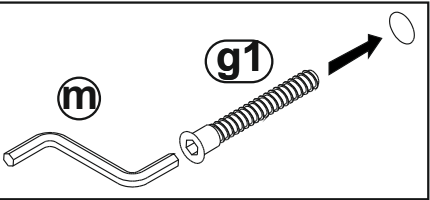
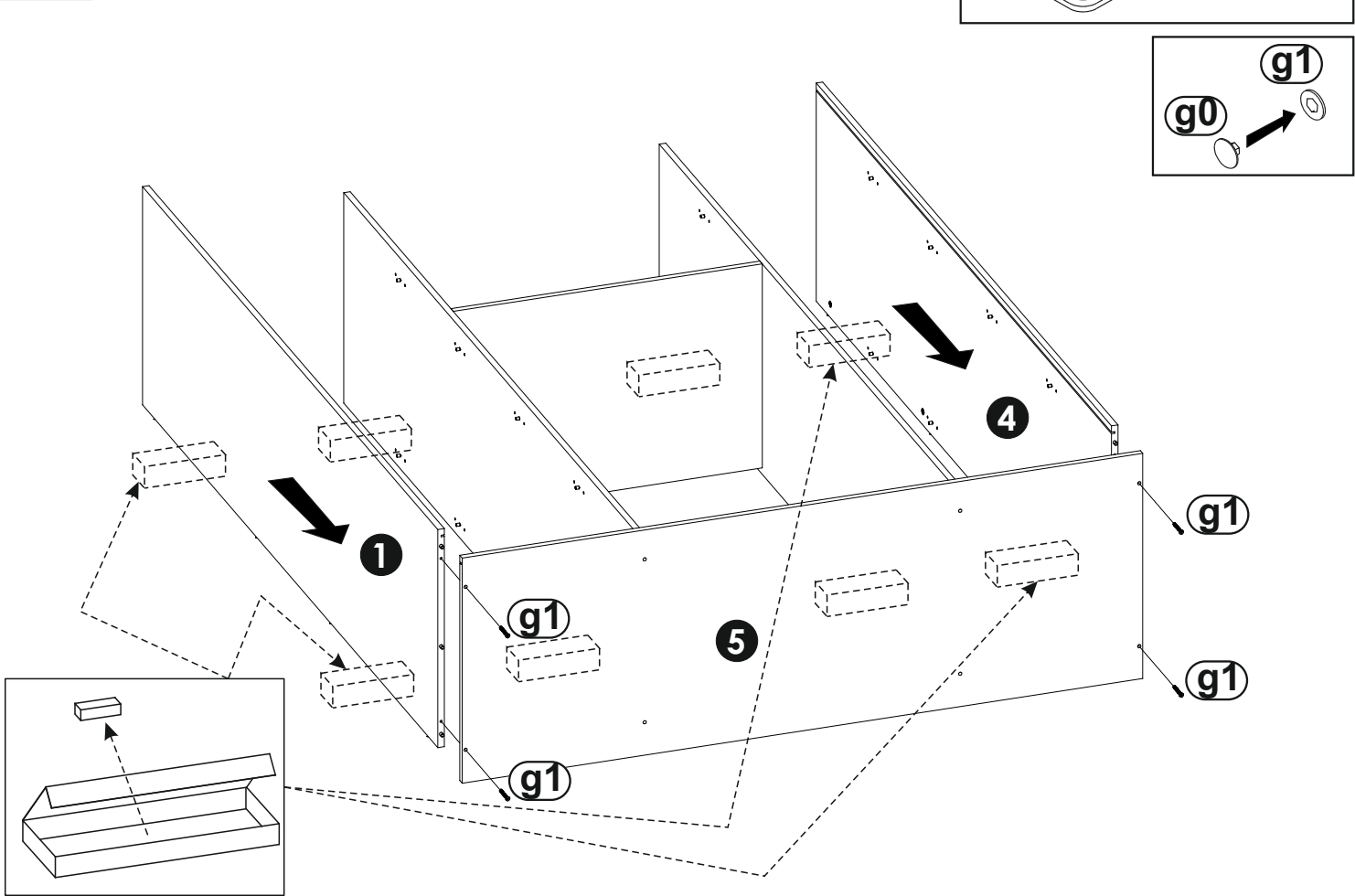
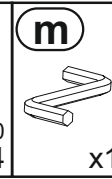
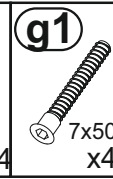
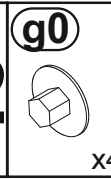

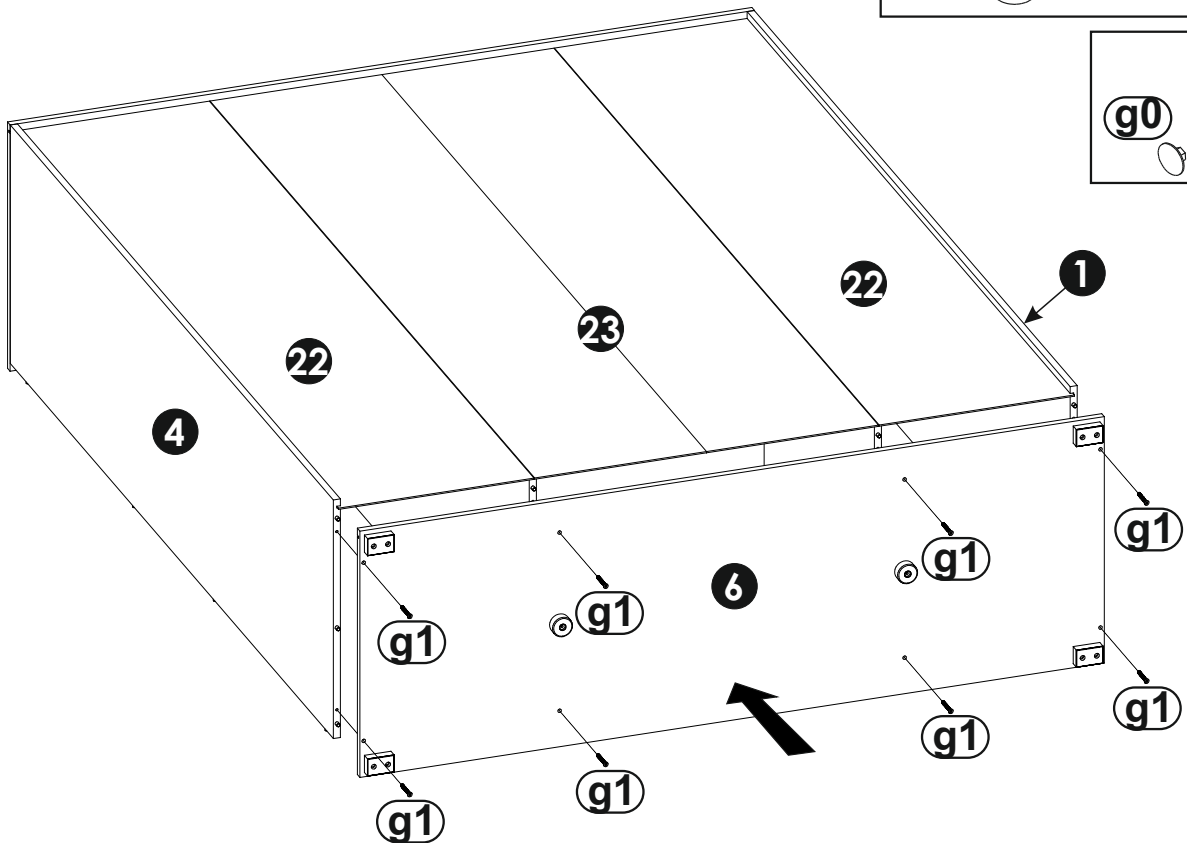
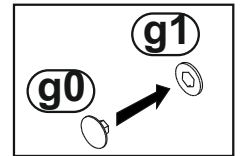
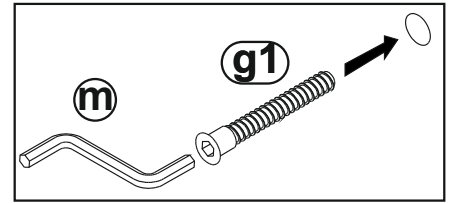
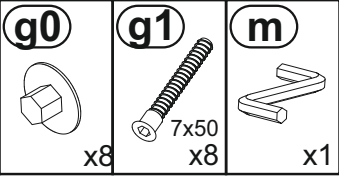
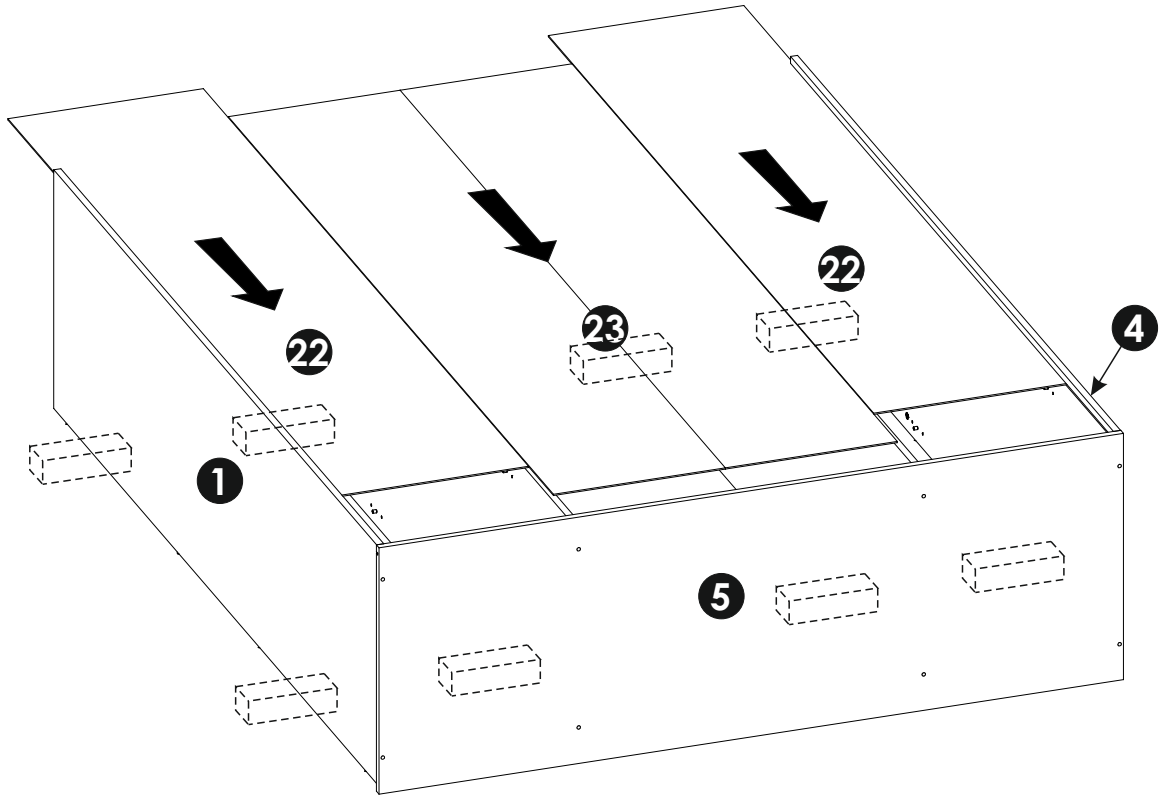

15

P11/24

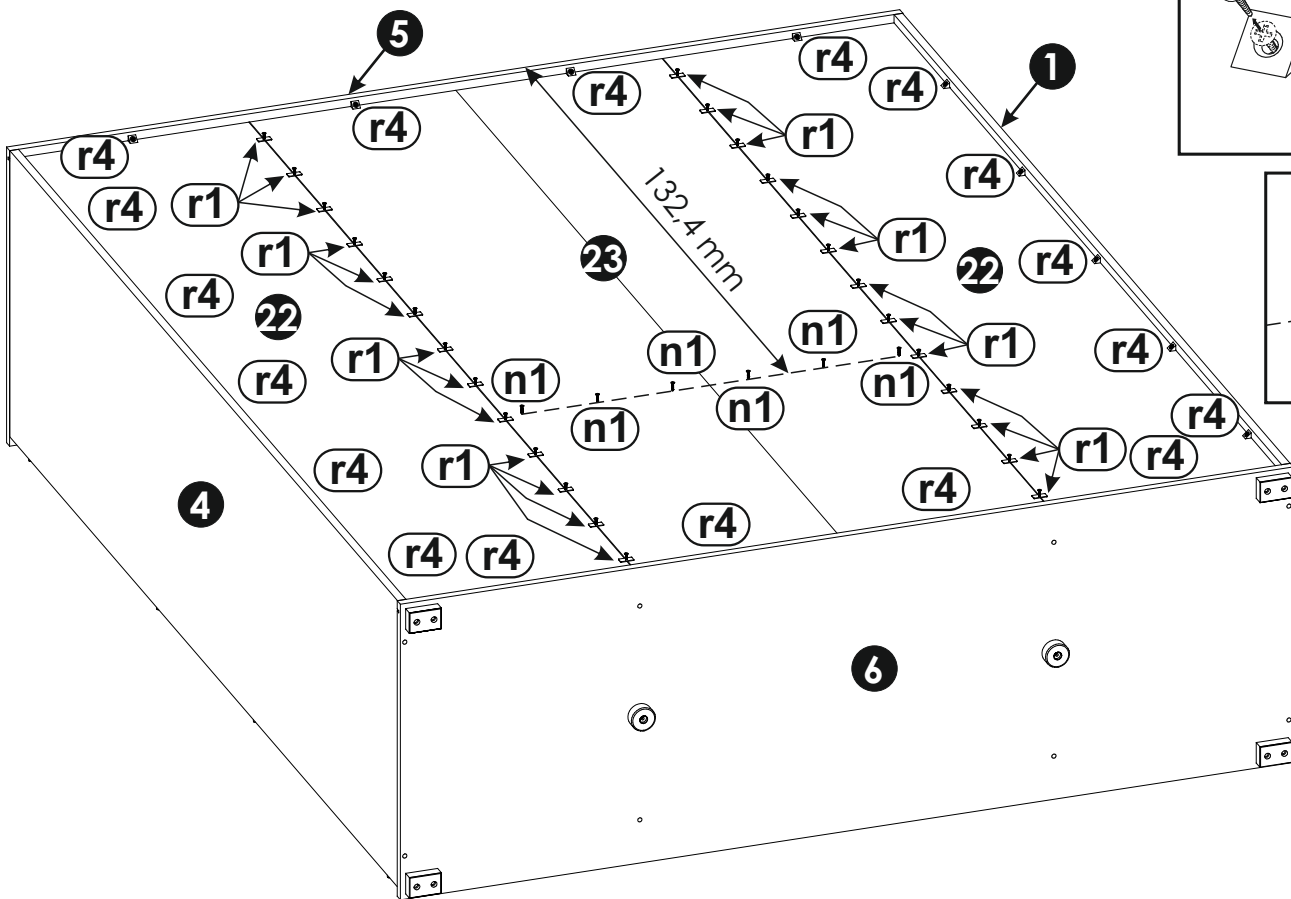
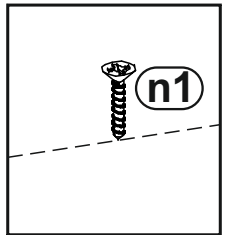
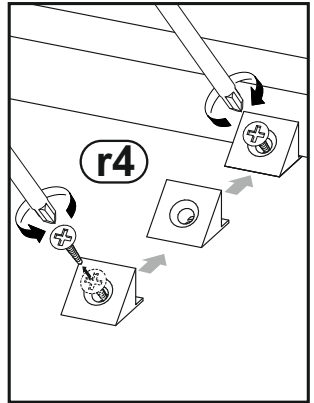
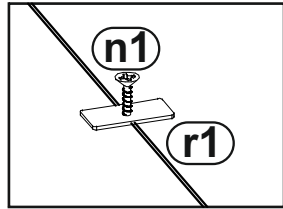
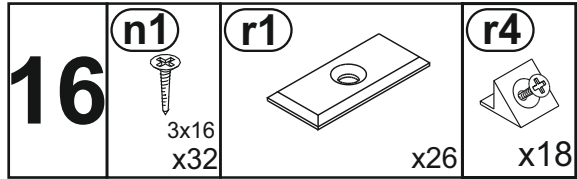
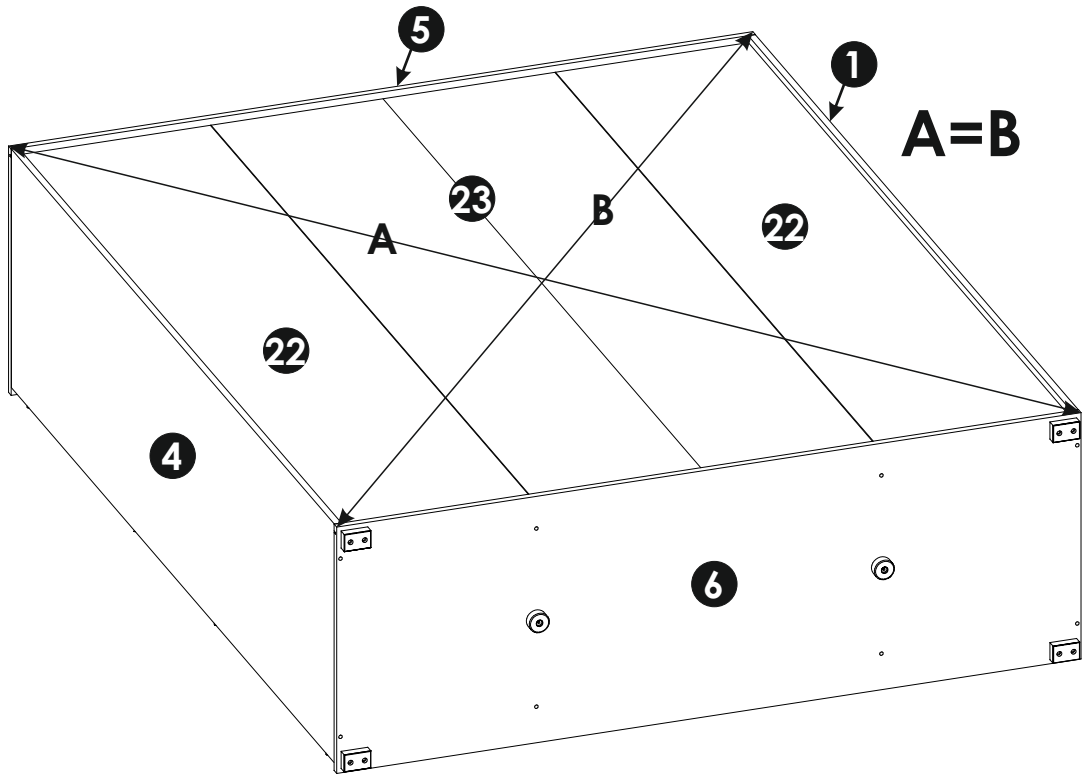

17 **i4**
4x27
x4

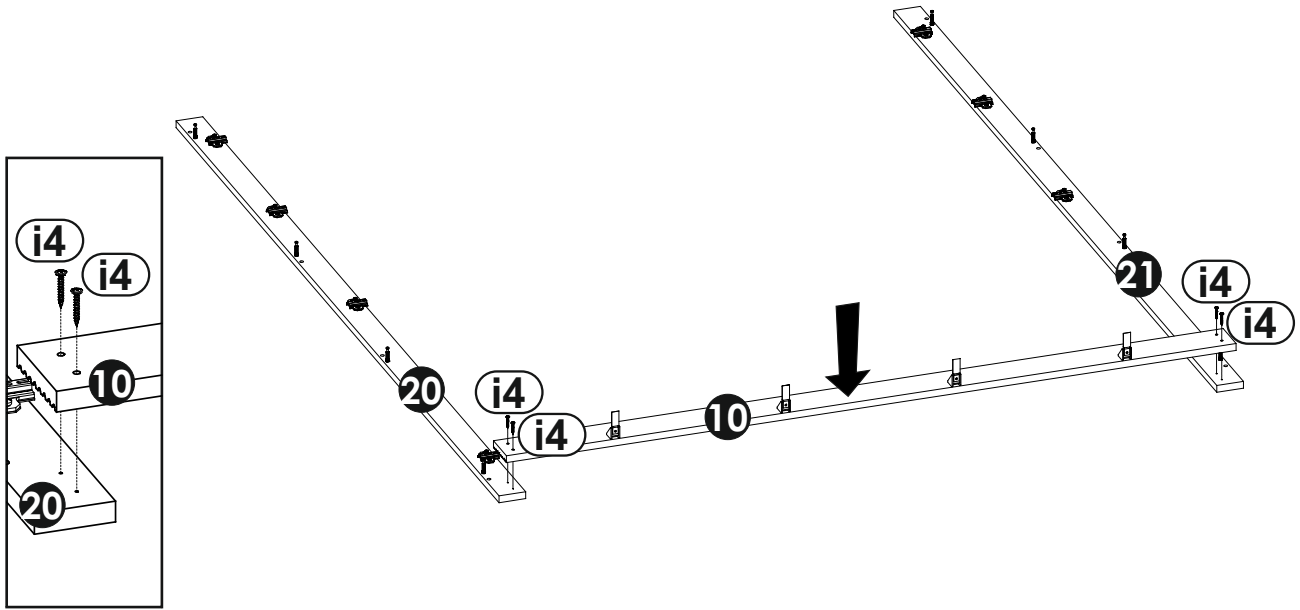

18 **e0** **m**
x8 x1

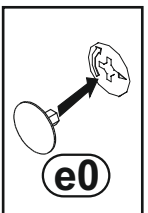
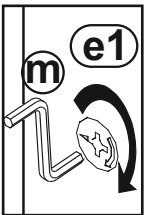
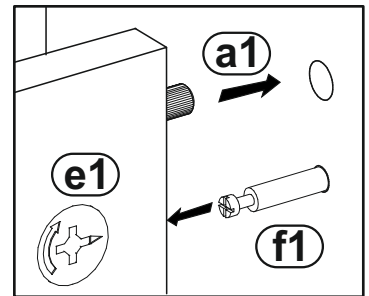
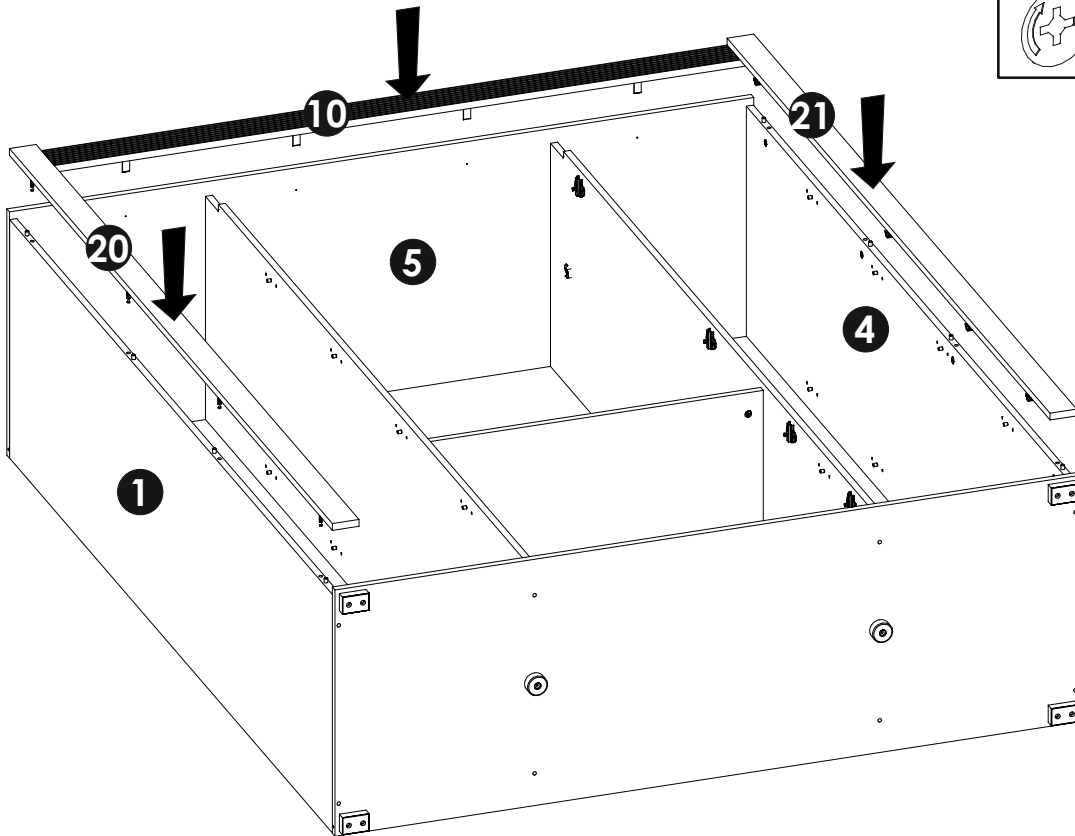

19

n2

3,5x16
x4

P13/24

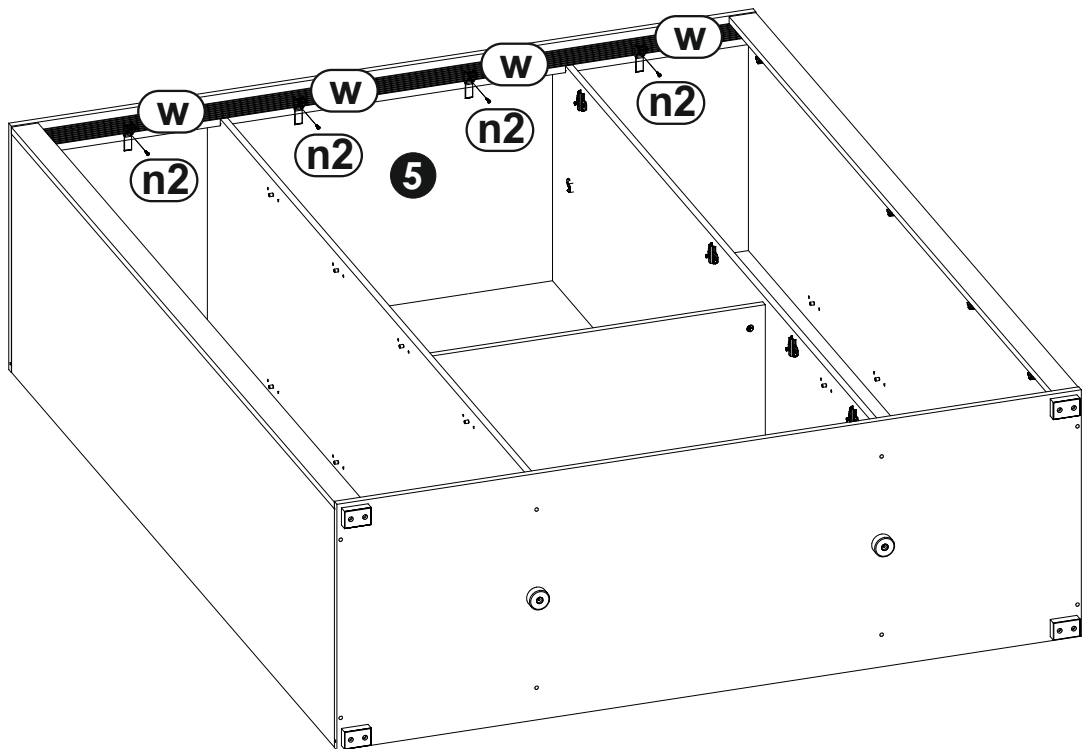
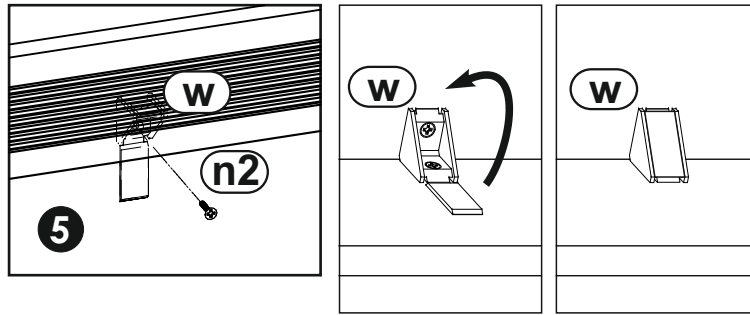

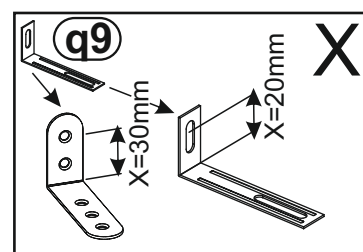
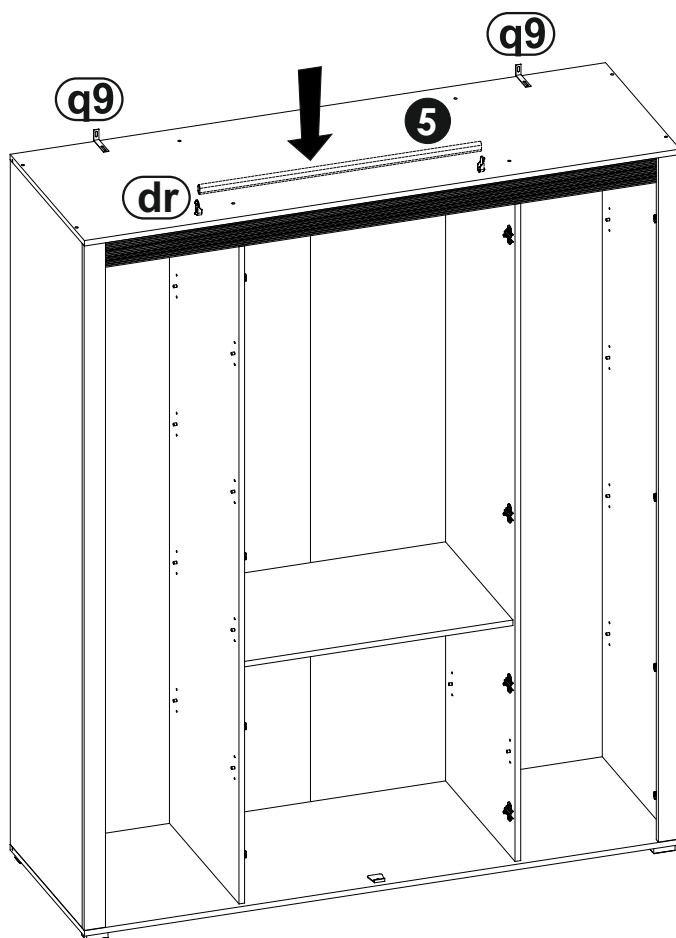
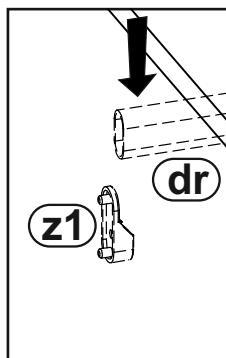
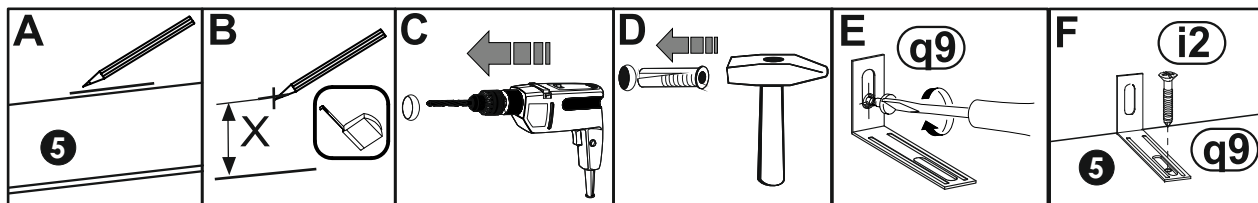
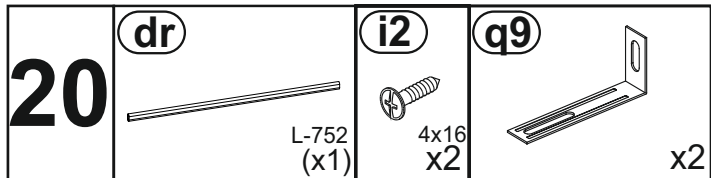

HR

VAŽNO: Da bi se izbjeglo slučajno tip-over namještaja, učvršćivanje namještaja na zid je obavezno.

Potreban hardver za spoj zida / namještaja, ovisno o prirodi zida,

Nije navedeno.

Ako imate bilo kakve sumnje,

SRB

VAŽNO: Da biste izbegli slučajno prevrtanja nameštaja, za fiksiranje na namještaja na zid je obavezna.

Potreban hardver za spoj zida / nameštaj, u zavisnosti od prirode zida, je

nije obezbeđeno.

Ako ikakve sumnje, obratiti se lekaru.

21

P15/24

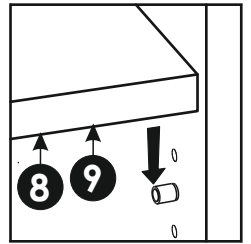
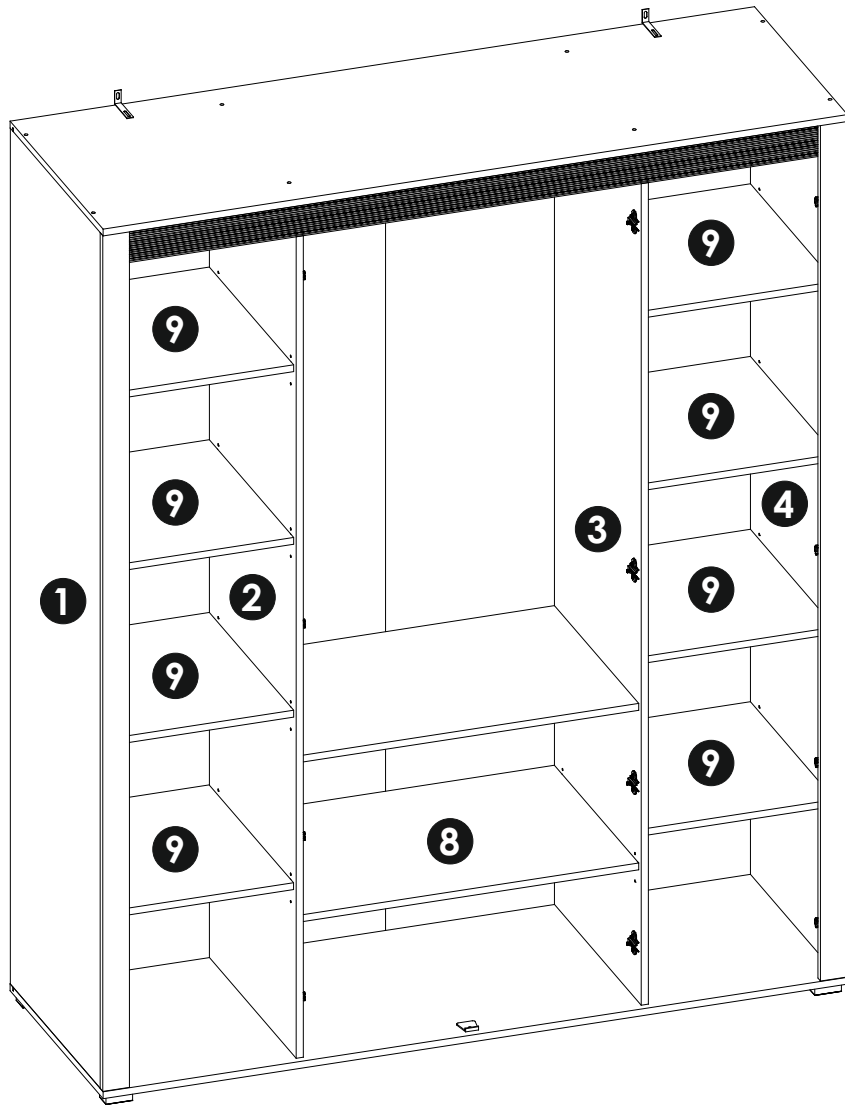

22



a0

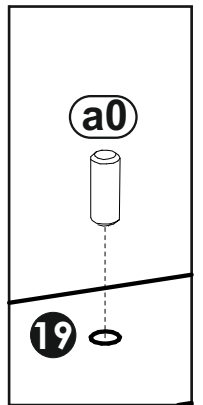
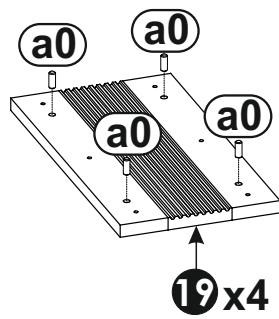

8x20
x16



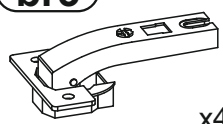

23

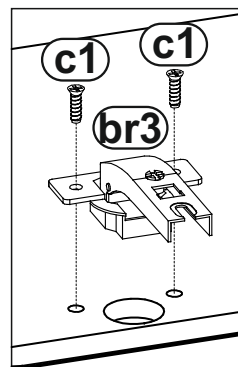
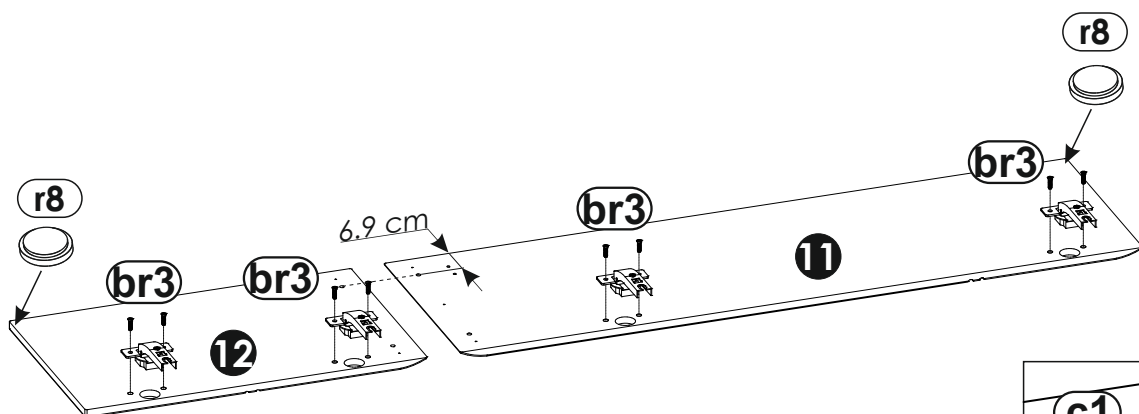
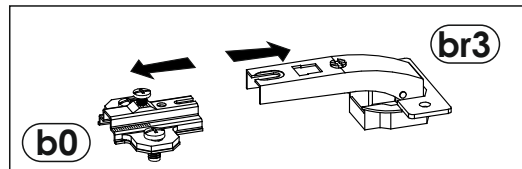
br3  x4	c1  Euro 4x13 x8	r8  x2
--	--	--



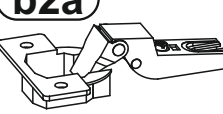

24

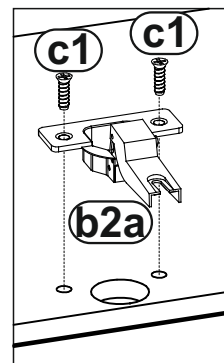
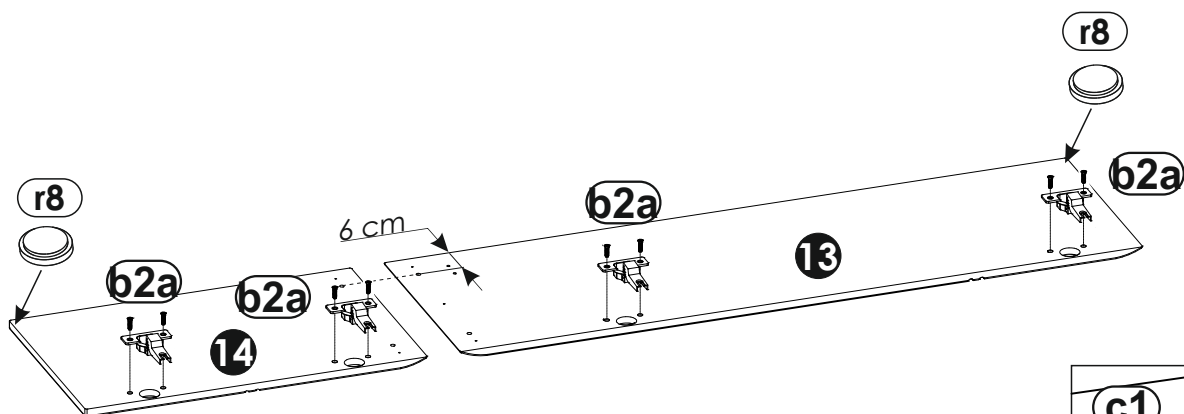
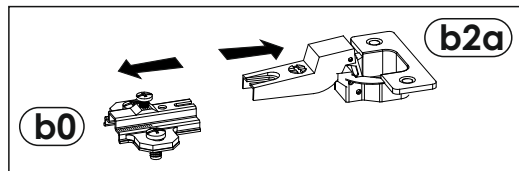
b2a  x4	c1  Euro 4x13 x8	r8  x2
---	---	--



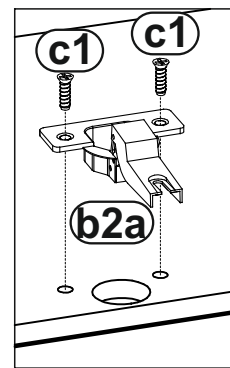
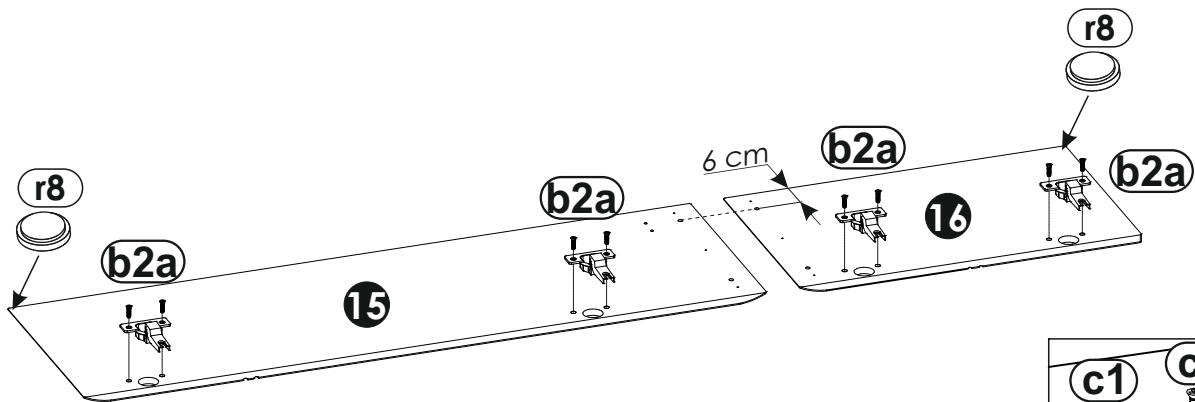

25

b2a  x4	c1  Euro 4x13 x8	r8  x2
---	---	--



26

br3  x4	c1  Euro 4x13 x8	r8  x2
---	---	--

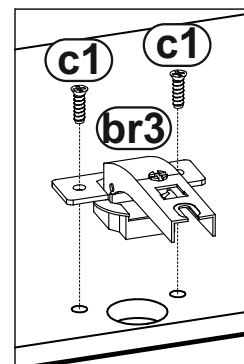
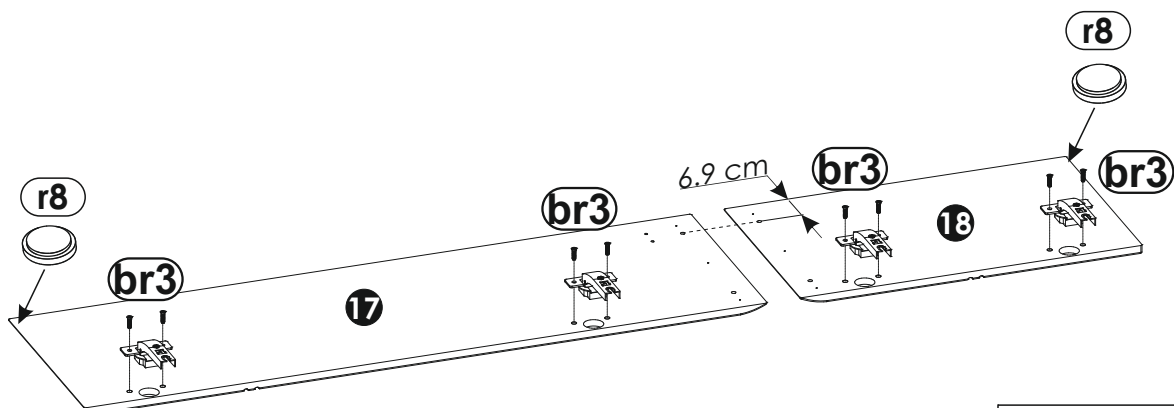
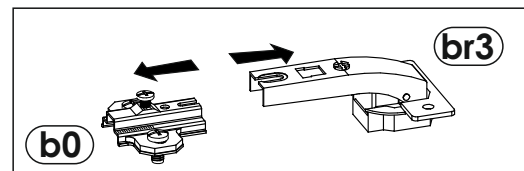

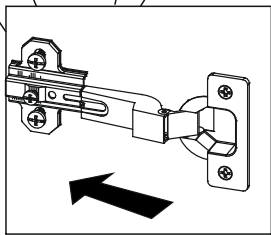
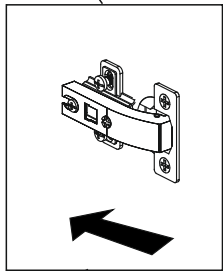
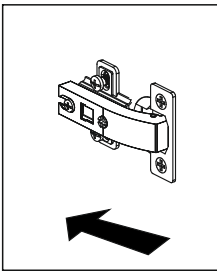
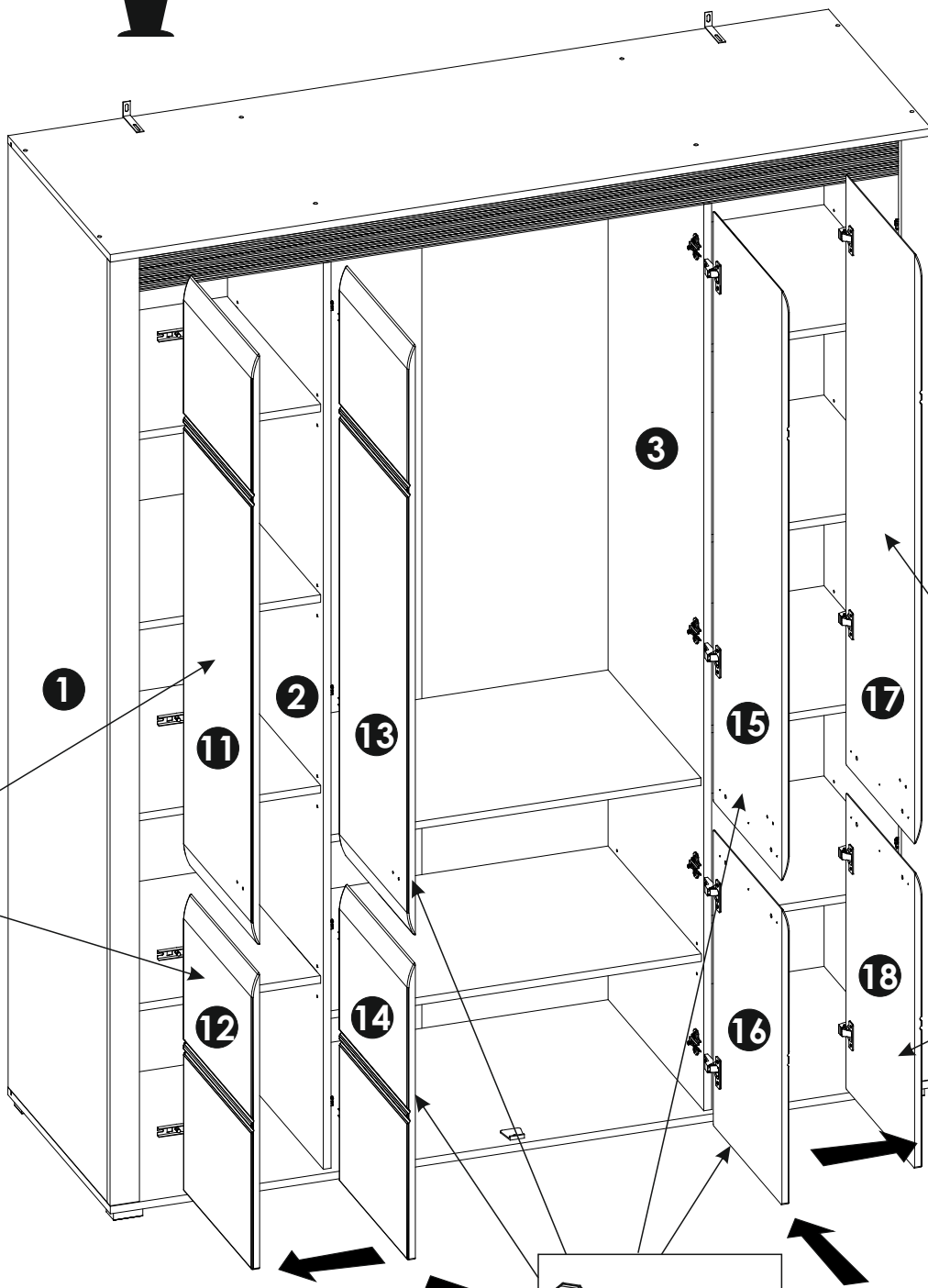
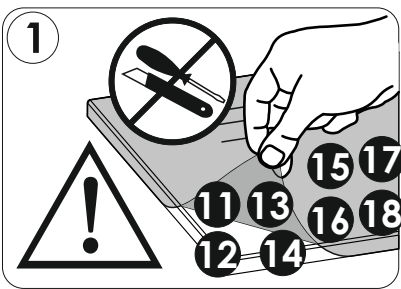

28

j2



p16



x24

P19/24

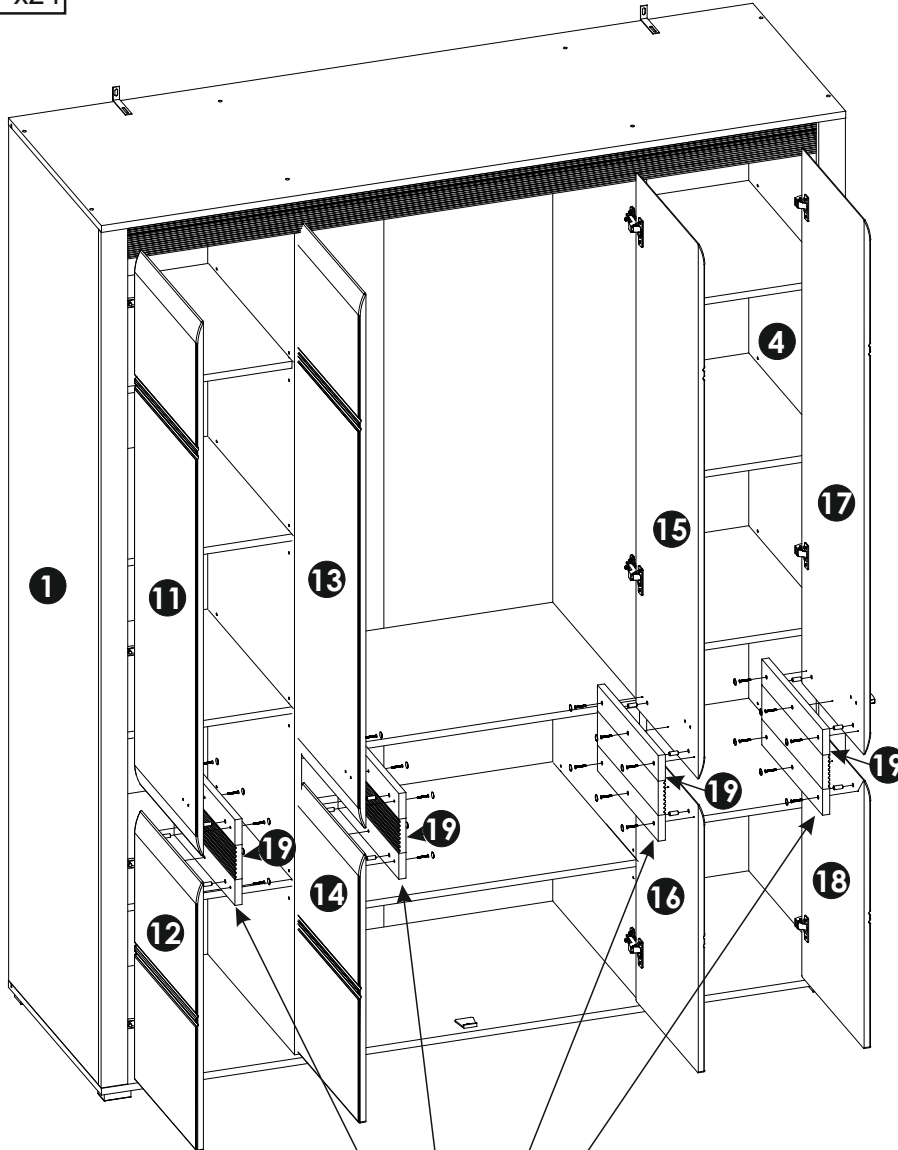

1

2

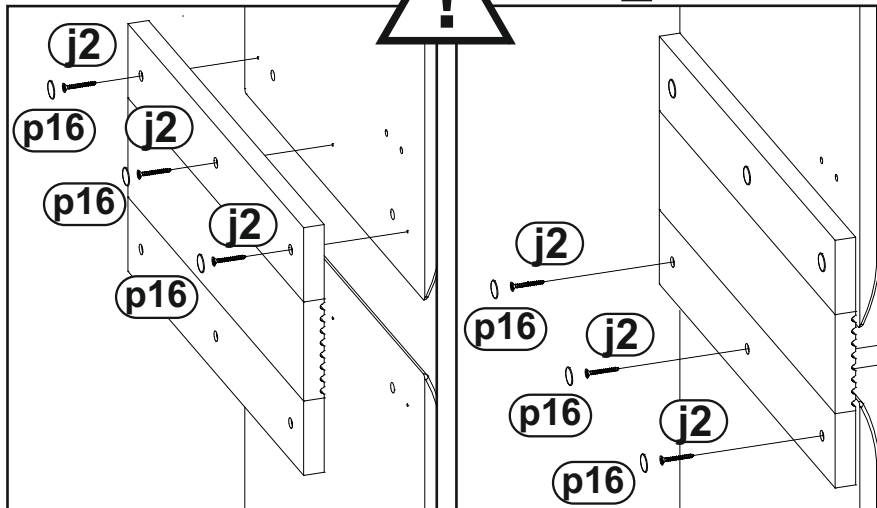

29

h1



x4

k3



M4x22
x8

P20/24

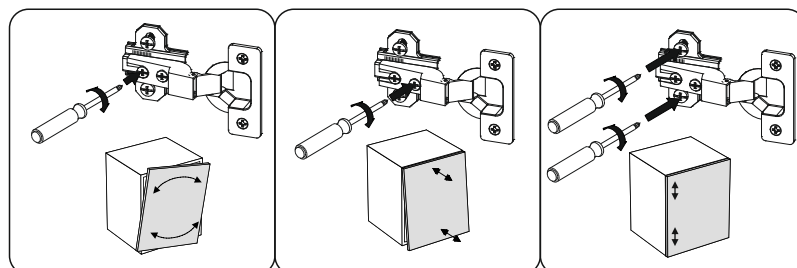
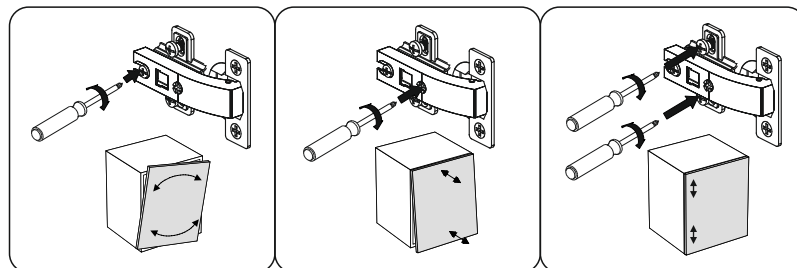
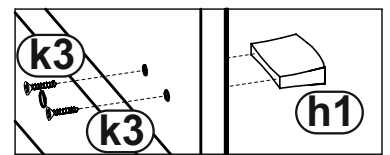
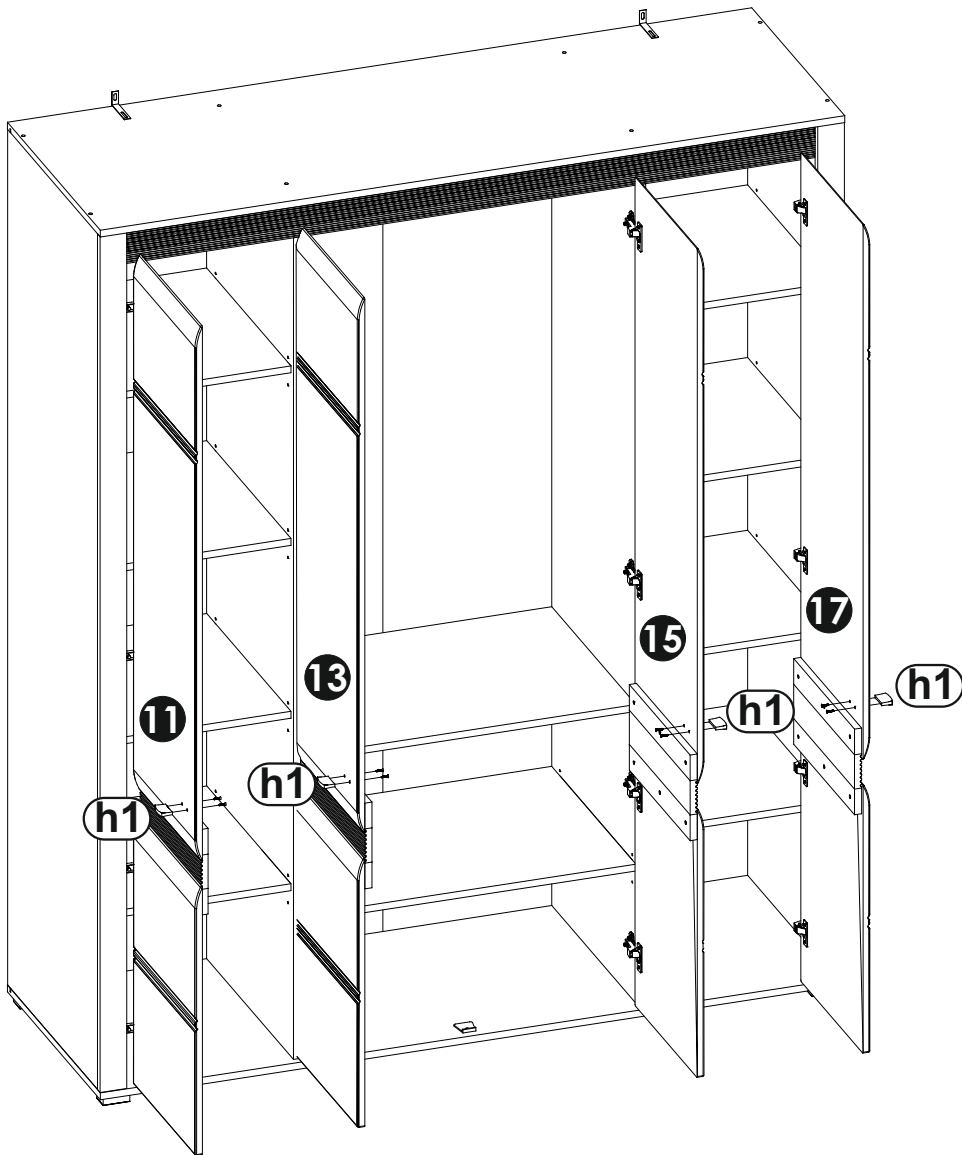

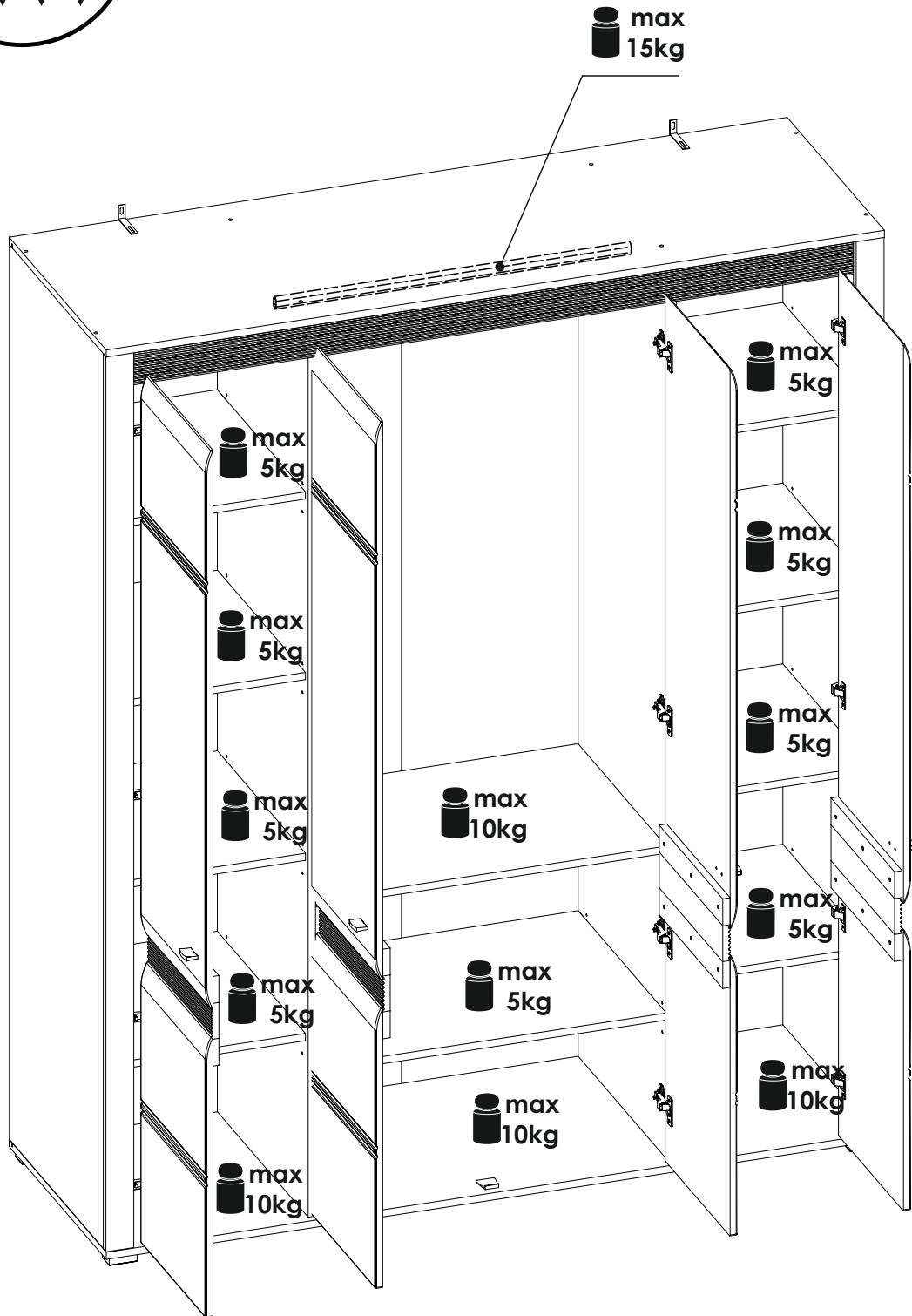

FRANCAIS - SUISSE

CONSEILS DE MONTAGE :

- 1 > BIEN ETUDIER LA NOTICE DE MONTAGE.
- 2 > REPEREZ LES PIÈCES CONSTITUANT VOTRE MEUBLE.
- 3 > REGROUPEZ ET CONTROLEZ LA QUINCAILLERIE.
- 4 > MUNISSEZ-VOUS DE L'OUTILLAGE NECESSAIRE.
- 5 > AMENAGEZ-VOUS UNE ZONE DE MONTAGE.
- 6 > PROCEDEZ AU MONTAGE.



NE JAMAIS FORCER LES ASSEMBLAGES. RESERRER LES VIS APRES QUELQUES TEMPS D'USAGE. GARDER VOTRE NOTICE DE MONTAGE, SI UNE PIECE VENAIT A MANQUER, ELLE SERAIT LE PLUS CLAIR MOYEN DE COMMUNIQUER AVEC VOTRE MAGASIN.

CONSEILS D'ENTRETIEN :

- 1 > DÉPOUSSIÉREZ SOIGNEUSEMENT.
- 2 > HUMECTER UN CHIFFON DOUX ET PROPRE D'EAU LÉGÈREMENT SAVONNEUSE (OU DÉTERGENT).



- NE JAMAIS UTILISER DE PRODUITS ABRASIFS: POUDRE, LAINE D'ACIER, SOLVANTS. - NE PAS MOUILLER TROP COIEUSEMENT.

	PAPIER DECOR	SURFACES STRATIFIÉES	SURFACES LAQUÉES	BOIS VERNIS	TEXTILE CUIR
EAU SAVONNEUSE (SAVON NEUTRE)	○	○	○	○	○
EAU ADDITIONNÉE		○	○		
ENTRETIEN SPÉCIFIQUE FABRICANT					○

DEUTSCH - SCHWEIZ

MONTAGE ANLEITUNG:

- 1 > DIE MONTAGEANLEITUNG SORGFÄLTIG DURCHLESEN.
- 2 > DIE EINZELTEILE DES MÖBELSTÜCKS ERMITTELN.
- 3 > DIE BESCHLÄGE ZUSAMMENLEGEN UND PRÜFEN.
- 4 > DAS NOTWENDIGE WERKZEUG ZURECHTLEGEN.
- 5 > EINEN MONTAGEBEREICH FREIMACHEN.
- 6 > DAS MÖBELSTÜCK ZUSAMMENBAUEN.



NIEMALS DIE VERBINDUNGEN ZU STARK ANZIEHEN. DIE SCHRAUBEN NACH EINIGER ZEIT DES GEBRAUCHS ERNEUT FESTZIEHEN. DIE MONTAGEANLEITUNG GUT AUFBEWAHREN: SOLLTE EIN TEIL FEHLEN, IST SIE DAS BESTE VERSTÄNDIGUNGSMITTEL MIT IHREM GESCHÄFT.

PFLEGEHINWEISE :

- 1 > SORGFÄLTIG ENTSTAUBEN.
- 2 > MIT EINEM WEICHEN, SAUBEREN UND FEUCHTEM TUCH UND LEICHTER SELFENTAUGE REINIGEN.



- BENUTZEN SIE KEINE SCHEUERMITTEL WIE PULVER, STAHLWOLLE, LÖSUNGSMITTEL. - NICHT ZU NASS ABWLSCHEN.

	DEKORPAPIER	OBERFLÄCHE LAMINAT	OBERFLÄCHE LACK	LACKIERTEM HOLZ	TEXTIL LEDER
SEIFENLAUGE (NEUTRALSEIFE)	○	○	○	○	○
WASSER MIT HAUSHALTSRFINIGER		○	○		
PRODUZENT SPEZIFISCHER UNTERHALT					○

ITALIANO - SVIZZERA

CONSIGLI DI MONTAGGIO

- 1 > STUDIARE BENE LE ISTRUZIONI DI MONTAGGIO.
- 2 > PRENDERE CONOSCENZA DEI PEZZI CHE COSTITUISCONO IL MOBILE.
- 3 > RAGGRUPPARE E CONTROLLARE LA FERRAMENTA.
- 4 > MUNIRSI DEGLI UTENSILI NECESSARI.
- 5 > PREPARARE UNA ZONA DI MONTAGGIO.
- 6 > PROCEDERE AL MONTAGGIO.



NON FORZARE MAI GLI ASSEMBLAGGI. RESTRINGERE LE VITI DOPO UN PERIODO D'UTILIZZO. CONSERVARE QUESTE ISTRUZIONI DI MONTAGGIO, POICHE', SE UN PEZZO DOVESSE MANCARE, ESSE SAREBBERO IL MIGLIORE MEZZO DI COMUNICAZIONE CON IL RIVENDITORE

CONSIGLI PER LA MANUTENZIONE :

- 1 > SPOLVERATE ACCURATAMENTE.
- 2 > INUMIDIRE CON ACQUA LEGGERMENTE INSAPONATA UNO STRACCIO MORBIDO E PULITO.



- NON UTILIZZARE MAI PRODOTTI ABRASIVI: POLVERE, LANA DI ACCIAIO, SOLVENTI. - NON BAGNARE ECCESSIVAMENTE.

	CARTA	SUPERFICI STRATIFICATE	SUPERFICI LACCATE	SUPERFICI LACCATE / LEGNO VERNICIATO	TESSILE / CUIRO
ACQUA CON SAPONE (SAPONE NEUTRO)	○	○	○	○	○
ACQUA CON DETERSIVO		○	○		
MANUTENZIONE SPECIFICA PRODUTTORE					○

TÜRKÇE

MONTAJ TALİMATLARI:

- 1 > Montaj tanıtım yazısını dikkatlice okuyunuz.
- 2 > Mobilyanızı oluşturan parçaları işaretleyiniz.
- 3 > Hırdavatla ilgili parçaları bir araya toplayıp; kontrol ediniz.
- 4 > Gereken araç ve gereci tedarik ediniz.
- 5 > (Kendinize) Bir montaj alanı ediniz.
- 6 > Monte etmeye başlayınız.



MONTAJLARI ZORLAMAYINIZ.
BİRKAÇ KULLANIMDAN SONRA VİDALARI SIKIŞTIRINIZ.
BİR PARÇANIN KAYBOLMASI DURUMUNDA MAĞAZANIZLADAKİ
KOLAY İLETİŞİME GEÇEBİLMEYİ İÇİN MONTAJ KULLANIM
TALİMATINIZI SAKLAYINIZ.

BAKIM TALİMATLARI:

- 1 > TOZUNU DİKKATLİCE ALINIZ.
- 2 > YUMUŞAK BİR BEZİ TEMİZ SU VE AZ MİKTARDA SABUNLA(DETERJAN) NEMLENDİRİNİZ.



- ASLA AŞINDIRICI ÜRÜNLER
KULLANMAYINIZ : ÇELİK YÜNÜ,
SOLVENT...
- BOL SUYLA YIKAMAYINIZ.

	SÜS KAĞIDI	KATMAN YÜZEY	LAKE YÜZEY	ÇİRALI TAHTA	TEKSTİL DERİ
SABUNLU SU (NÖTR SABUN)	○	○	○	○	○
DETERJAN KATILMIŞ SU		○	○		
ÜRETİCİYE ÖZGÜ BAKIM					○

ENGLISH

ASSEMBLY ADVICE :

- 1 > CAREFULLY READ THE ASSEMBLY INSTRUCTION.
- 2 > IDENTIFY THE COMPONENTS OF THE FURNITURE.
- 3 > GROUP AND CHECK THE HARDWARE.
- 4 > USE THE REQUIRED TOOLS.
- 5 > CREATE AN ASSEMBLY ZONE.
- 6 > MAKE THE ASSEMBLY.



NEVER FORCE THE CONNECTIONS.
RE-TIGHTEN THE SCREWS AFTER FEW DAYS.
PLEASE RETAIN THE AI LEAFLET FOR FUTURE REFERENCE,
THE AI CONTAINS INFORMATION WHEN CLAIMING
FOR MISSING PARTS.

CLEANING ADVICE:

- 1 > CAREFULLY REMOVE THE DUST.
- 2 > USE A SOFT, CLEAN DAMP CLOTH WITH SOAPY WATER.



NEVER USE ABRASIVE PRODUCTS
OR SOLVENTS.
DO NOT APPLY EXCESSIVE PRESSURE
WHEN USING THE DAMP CLOTH.

	PAPER DECOR	LAMINATED SURFACES	LACQUERED SURFACE	VARNISHED WOOD	LEATHER TEXTILE
SOAPY WATER (NEUTRAL SOAP)	○	○	○	○	○
WATER WITH DETERGENT		○	○		
SPECIFIC SUPPLIER CLEANING					○

SRBIJA

SAVETI ZA MONTAŽU:

1. PAŽLJIVO PROČITAJTE UPUTSTVA ZA MONTAŽU
2. PROVERITE DA LI IMATE SVE DELOVE
3. SAKUPITE I PROVERITE OKOVE ZA MONTAŽU
4. PRIPREMITE POTREBAN ALAT
5. PRIPREMITE PROSTOR ZA MONTAŽU
6. POČNITE DA MONTIRATE
7. SAČUVAJTE OVA UPUTSTVA
8. PROIZVOD JE NAMENJEN ISKLJUČIVO ZA KUĆNU UPOTREBU



NEMOJTE UPOTREBLJAVATI SILU PRILIKOM SKLAPANJA, NAKON
NEKOG VREMENA PONOVO PRITEGNITE ŠRAFOVE, ČUVAJTE
UPUTSTVA ZA MONTAŽU, U SLUČAJU NEDOSTATAKA NEKOG DELA
NAJBOLJE DA KONTAKTIRATE PRODAJNO MESTO.

UPUTSTVA ZA ODRŽAVANJE:

1. PAŽLJIVO OBRISATI PRAŠINU
2. PREBRISATI ČISTOM, MEKOM TKANINOM NAVLAŽENOM U BLAGOM RASTVORU SAPUNA ILI DETERDŽENTA



ZABRANJENA UPOTREBA HEMIKALIJA ILI BILO KAKVIH
POMOĆNIH SREDSTAVA ZA RIBANJE, JAKIH
SREDSTAVA ZA ČIŠĆENJE ILI ČELIČNE ŽICE.
ZABRANJENO ČIŠĆENJE SA PREVIŠE VODE/VLAGE.

	HARTIJA	LAMINAT	LAK	DRVO	TEKSTIL/KOŽA
RASTVOR SAPUNA	○	○	○	○	○
RASTVOR DETERDŽENTA		○	○		
NAMENSKA SREDSTVA					○

PROIZVOD JE NAMENJEN ISKLJUČIVO ZA KUĆNU UPOTREBU

ESPAOL

CONSEJOS PARA EL MONTAJE:

- 1 > ESTUDIE ATENTAMENTE EL MANUAL DE MONTAJE.
- 2 > LOCALICE LAS PIEZAS QUE CONSTITUYEN SU MUEBLE.
- 3 > REUNA Y CONTROLE LOS TORNILLOS.
- 4 > EQUIPE-SE DE LAS HERRAMIENTAS NECESARIAS.
- 5 > PREPARE UMA ZONA DE MONTAJE.
- 6 > REALICE EL MONTAJE.



NO FUERCE NUNCA EN LAS UNIONES. APRIETE LOS TORNILLOS DESPUES DE CIERTO TIEMPO DE UTILIZACION CONSERVE SU MANUAL DE MONTAJE, SI FALTARA UNA PIEZA, SERIA LA MANERA MAS FACIL DE COMUNICAR CON LA TIENDA.

CONSEJOS PARA EL MANTENIMIENTO:

- 1 > DESPOLVOREAR CULDADOSAMENTE.
- 2 > HUMEDECER UN PANO SUAVE Y LIMPIO CON AGUA LIGERAMENTE ENJABONADA.



- NO USE NUNCA PRODUCTOS ABRASIVOS TALES COMO: POLVO DE LIMPIAR, LANA DE ACERO, SOLVENTES. - NO MOJAR EXAGERADAMENTE.

	PAPEL DE DECORACION	SUPERFICIE ESTRATIFICADAS	SUPERFICIE MAQUEADAS	MADERA BARNIZADA	TEXTIL CUERO
AGUA Y JABON (JABON NEUTRO)	○	○	○	○	○
AGUA COM DETERGENTE		○	○		
MANTENIMIENTO ESPECIFICO DEL FABRICANTE					○

PORTUGUS

CONSELHOS DE MONTAGEM:

- 1 > ESTUDE BEM AS INSTRUÇÕES DE MONTAGEM.
- 2 > REUNA AS PEÇAS QUE CONSTITUEM O SEU MÓVEL.
- 3 > REAGRUPE AS FERRAGENS.
- 4 > EQUIPE-SE COM AS FERRAMENTAS NECESSÁRIAS.
- 5 > PREPARE UMA ÁREA PARA A MONTAGEM.
- 6 > INICIE A MONTAGEM.



NUNCA FORÇAR OS ENCAIXES. REAPERTAR OS PARAFUSOS APÓS UM TEMPO DE UTILIZAÇÃO. GUARDAR AS INSTRUÇÕES DE MONTAGEM. CASO FALTE ALGUMA PEÇA, O MAIS ACONSELHÁVEL É CONTATAR O REVENDEDOR.

CONSELHOS PARA A MANUTENÇÃO :

- 1 > ELIMINAR BEM O PÓ.
- 2 > UMEDECER UM PANO SUAVE E LIMPO COM ÁGUA E UM POUCO DE SABO.



- NUNCA UTILIZAR PRODUTOS ABRASIVOS: SAPONÁCEOS, L DE AÇO, SOLVENTES. - NO MOLHAR DEMASIADO.

	ACABAMENTO IMITAÇÃO	SUPERFÍCIES ESTRATIFICADAS	SUPERFÍCIES LACADAS	MADEIRA ENVERNIZADA	TEXTIS PELES
ÁGUA COM SAB O (SABO NEUTRO)	○	○	○	○	○
ÁGUA COM DETERGENTE		○	○		
INSTRUCES ESPECÍFICAS DO FABRICANTE					○

HRVATSKA

UPUTE ZA MONTAŽU:

- 1 > PAŽLJIVO PROČITAJTE UPUTE ZA MONTAŽU.
- 2 > PRIPREMITE SVE DIJELOVE NAMJEŠTAJA.
- 3 > PRIKUPITE I PROVJERITE OKOVE ZA MONTAŽU.
- 4 > PRIPREMITE POTREBAN ALAT.
- 5 > PRIPREMITE PROSTOR ZA MONTAŽU.
- 6 > POČNITE MONTIRATI.
- 7 > SAČUVAJTE OVE UPUTE.
- 8 > PROIZVOD JE NAMJENJEN ISKLJUČIVO ZA KUĆNU UPORABU.



NEMOJTE UPOTREBLJAVATI SILU PRILIKOM SKLAPANJA NAKON NEKOG VREMENA PONOVRNO PRITEGNITE VIJKE ČUVAJTE UPUTE ZA MONTAŽU, U SLUČAJU NEDOSTATKA NEKOG DIJELA NAJBOLJE ĆE BITI DA KONTAKIRATE PRODAJNO MJESTO.

UPUTE ZA ODRŽAVANJE:

- 1 > PAŽLJIVO OBRISATI PRAŠINU.
- 2 > PREBRISATI ČISTOM, MEKOM TKANINOM NAVLAŽENOJ U BLAGOJ OTOPINI SAPUNA ILI DETERD ŽENTA.



-ZABRANJENA JE UPOTREBA KEMIKALIJA ILI BILO KAKVIH POMOĆNIH SREDSTAVA ZA RIBANJE JAKIH SREDSTAVA ZA ČIŠĆENJE ILI ČELIČNE VUNE. -ZABRANJENO JE ČIŠĆENJE SA PREVIŠE VODE/VLAGE.

	PAPIR	LAMINAT	LAK	DRVO	TEKSTIL / KOŽA
OTPINA SAPUNA	○	○	○	○	○
OTPINA DETERDŽENTA		○	○		
NAMJENSKA SREDSTVA					○

PROIZVOD JE NAMJENJEN ISKLJUČIVO ZA KUĆNU UPORABU!